

Operation Manual

Power Distributor **PD-6359A**

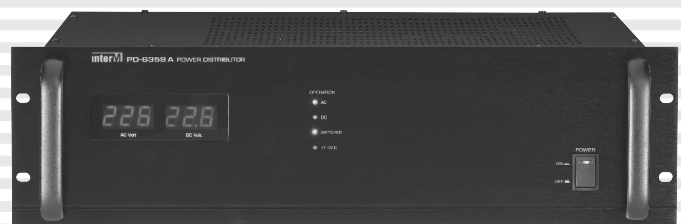

* Rack mount products in the Western Hemisphere(North America, South America, and the Caribbean) do not have handles installed due to customer preference.

interM

Welcome

A personal welcome to you from the management and employees of Inter-M

All of the co-workers here at Inter-M are dedicated to providing excellent products with inherently good value, and we are delighted you have purchased one of our products.

We sincerely trust this product will provide years of satisfactory service, but if anything is not to your complete satisfaction, we will endeavor to make things right.

Welcome to Inter-M, and thank you for becoming part of our worldwide extended family!

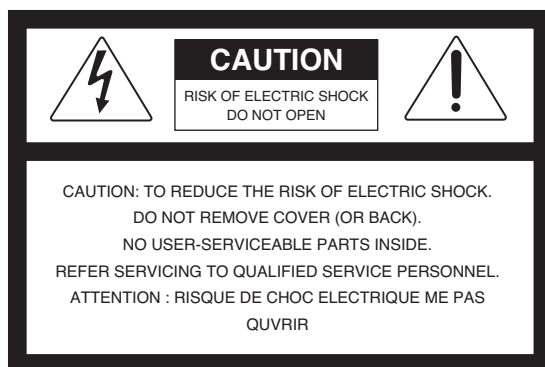

WARNING

To prevent fire or shock hazard, do not expose the unit to rain or moisture.



This symbol is intended to alert the user to the presence of uninsulated "dangerous voltage" within the product's enclosure that may be of sufficient magnitude to constitute a risk of electric shock to persons.



This symbol is intended to alert the user to the presence of important operation and maintenance (servicing) instructions in the literature accompanying the appliance.

Caution: To prevent electric shock do not use this (polarized) plug with an extension cord, receptacle or other outlet unless the blades can be fully inserted to prevent blade exposure.

Attentions: Pour prévenir les chocs électriques ne pas utiliser cette fiche polarisée avec un prolongateur, une prise de courant ou une autre sortie de courant, sauf si les lames peuvent être insérées à fond sans en laisser aucune partie à découvert.
Pour déconnecter complètement l'appareil du réseau d'alimentation. déconnecter le cordon d'alimentation de la prise murale.
La prise du réseau d'alimentation doit demeurer aisément accessible.

*WARNING FOR YOUR PROTECTION PLEASE READ THE FOLLOWING-WATER AND MOISTURE: Unit should not be used near water(e.g. near a bathtub, washbowl, kitchen sink, laundry tub, in a wet basement, or near a swimming pool, etc). Care should be taken so than objects do not fall and liquids are not spilled into the enclosure through openings.

*Do not install this equipment in a confined space such as a book case or similar unit.

*This apparatus shall not be exposed to dripping or splashing and no objects filled with liquids, such vases, shall be placed on the apparatus.

*This apparatus shall be connected to a mains socket outlet with a protective earthing connection.

*It has heed to be easy to disconnect the device. To disconnect the device from power, separate AC input cable from inlet or unplug the AC Cord.

CAUTION

*These servicing instructions are for use by qualified service personnel only. To reduce the risk of electric shock, do not perform any servicing other than that contained in the operating instructions unless you are qualified to do so.

NOTE

*This equipment has been tested and found to comply with the limits for a Class A digital device, pursuant to Part 15 of the FCC Rules. These limits are designed to provide reasonable protection against harmful interference when the equipment is operated in a commercial environment. This equipment generates, uses, and can radiate radio frequency energy and, if not installed and used in accordance with the instruction manual, may cause harmful interference to radio communications. Operation of this equipment in a residential area is likely to cause harmful interference in which case the user will be required to correct the interference at his own expense.

Contents

Unpacking	2
Installation	
Environment.....	2
Important Safety Instructions.....	2
Features	3
Caution when assembling the Racks	3
Package and accessory includes	3
Equipment Setting and Checking	4
Front Panel	6
Rear Panel	7
Applications	10
Block Diagram	11
Specifications	12
Service	
Procedures.....	14
Schematic.....	14
Parts List	14
Variations and Options	14
Warranty	14

Unpacking

Although your PD-6359A is neither complicated nor difficult to operate, we recommend you take a few minutes to read this brief manual and familiarize yourself with the important information regarding product features, setup and operation.

As with most electronic devices, we strongly recommend you retain the original packaging. In the unlikely event the product must be returned for servicing, the original packaging (or reasonable equivalent) is required.

Installation

Environment

Never place this product in an environment which could alter its performance or reduce its service life. Such environments usually include high levels of heat, dust, moisture, and vibration.

IMPORTANT SAFETY INSTRUCTIONS

1. Read these instructions.
2. Keep these instructions.
3. Heed all warnings.
4. Follow all instructions.
5. Do not use this apparatus near water.
6. Clean only with dry cloth.
7. Do not block any ventilation openings. Install in accordance with the manufacturer's instructions.
8. Do not install near any heat sources such as radiators, heat registers, stoves, or other apparatus (including amplifiers) that produce heat.
9. Do not defeat the safety purpose of the polarized or grounding-type plug. A polarized plug has two blades with one wider than the other. A grounding type plug has two blades and a third grounding prong. The wide blade or the third prong are provided for your safety. If the provided plug does not fit into your outlet, consult an electrician for replacement of the obsolete outlet.
10. Protect the power cord from being walked on or pinched particularly at plugs, convenience receptacles, and the point where they exit from the apparatus.
11. Only use attachments/accessories specified by the manufacturer.
12. Use only with the cart, stand, tripod, bracket, or table specified by the manufacturer, or sold with the apparatus. When a cart is used, use caution when moving the cart/apparatus combination to avoid injury from tip-over.
13. Unplug this apparatus during lightning storms or when unused for long periods of time.
14. Refer all servicing to qualified service personnel. Servicing is required when the apparatus has been damaged in any way, such as power-supply cord or plug is damaged, liquid has been spilled or objects have fallen into the apparatus, the apparatus has been exposed to rain or moisture, does not operate normally, or has been dropped.



Features

- RACK SYSTEM POWER CONTROL

It controls the power of the rack system.

- AC OUTLET TERMINAL

It being consisted of UNSWITCHED 1 group and SWITCHED 3 group, and SWITCHED 3 group can output AC power sequentially. (By using the BY PASS setting switch, the time of AC power output can be controlled sequentially.)

- SUPPLY EMERGENCY POWER (DC 24V)

It can supply the battery power to the unswitched power output terminal, so it will be switched to emergency power in case of black out to supply the DC power to the system.

- MONITORING OF VOLTAGE SUPPLYING STATUS

The status of service voltage can be monitored through Windows program.

- REMOTE CONTROL

Power can be on/off from Windows program, and it can be controlled through the contact of remote terminal without PC.

- AC/DC VOLT METER

The status of service voltage can be monitored through front LED display consisting.

Caution when assembling the RACKs

- When using this device, exclusive model for our rack should be installed.
- If you decide to use the components made of other company, rated capacity should be verified, and confirm it with an authorized dealer nearby.
- Rated capacity should be verified.
- Connecting it while power is off.
- Connect AC and DC powers based on the power of the device to be connected.
- When supplying the rack power, interlock AC OUTLET (Switched: 15A×3/Unswitched: 3A×1) and DC power output (DC 24V, 5A) should be less than rated outputs.

Package and accessory includes

1. LAN cable x 1EA
2. Euro Terminal Block (5.08mm pitch) 3P x 1EA
3. User manual x 1EA

Equipment Setting and Checking

1. Address Setting

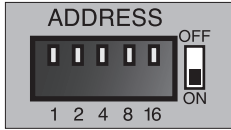

- 1) Setup the equipment number in accordance with connecting condition by using rear panel DIP switch. If the equipment number is not set, Err Id is displayed on AC / DC VOLT METER on front panel. When this happens, please check the equipment number setting. (Max. 20 can be connected)
- 2) The Setting should be as below table, and if data number is added to switch which is ON, it will be the equipment number.

Pin No.	1	2	3	4	5
Data	1	2	4	8	16
Address	1	ON			
	2		ON		
	3	ON	ON		
	4			ON	
	5	ON		ON	
	⋮	⋮	⋮	⋮	⋮
	15	ON	ON	ON	ON
	16				
⋮	⋮	⋮	⋮	⋮	⋮

(Ex: when number 1 and 3 switch is ON, 1 and 4 is added, so equipment number will be 5.)

2. TERMINATION Switch (LOAD/OPEN) Setting

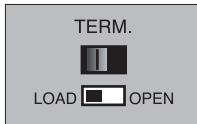

- 1) For the system linked by using RS-485 communication interface, it is necessary to set the termination switch (LOAD/OPEN) on the rear panel to stabilize data transfer.
- 2) Set the termination switch to LOAD only for the first and last-numbered equipment units. All others must be set to OPEN.

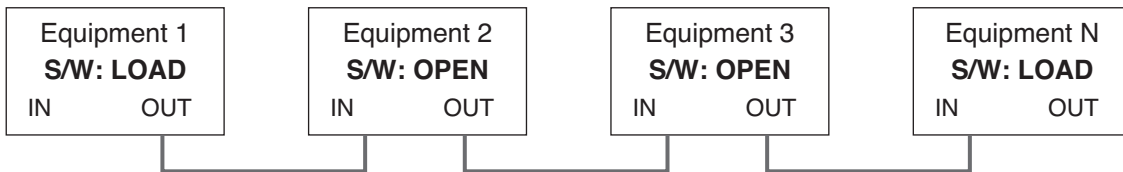

※ Caution: Communication error may occur if setting is performed incorrectly.

3. System Check

- 1) After supplying the power, check the power status of devices connected to this device.
- 2) Remove the AC power cord, then check the operation status with battery power in case of black out.
※ To prepare the black out, the battery and battery charger (PB-6207) is required.
- 3) Check on/off controls through remote terminal and monitoring status for communication.

Front Panel

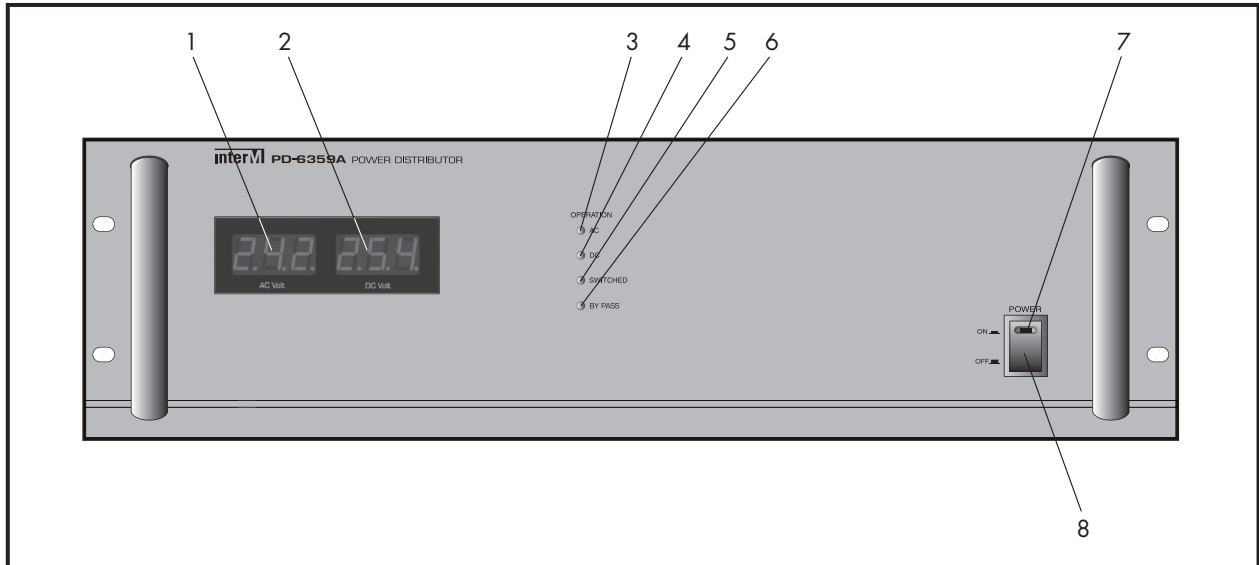

1. AC VOLT METER

It displays the AC power voltage.

※ When AC/DC is switched, the voltage is displayed after about 10 seconds.

2. DC VOLT METER

If PD-6359A is operated by AC power, DC output voltage is displayed. In case of AC power failure, if operated with DC power then DC input voltage is displayed.

※ When AC/DC is switched, the voltage is displayed after about 10 seconds.

3. AC LED

If operating power of PD-6359A is AC power, LED is turned on.

4. DC LED

If operating power of PD-6359A's is switched to DC power (battery) from AC power due to a power failure then LED is turned on.

5. SWITCHED LED

After AC power or DC power is applied to the equipment, then LED is turned on upon power switch is pressed.

6. BY PASS LED

This indicates the active status of BY PASS function. BY PASS LED is turned on upon the 4th switch is ON at BY PASS setting switch in the rear panel (If the equipment is operated by DC power, LED is turned on regardless of BY PASS setting).

7. POWER LED

LED is turned on only if power switch is pressed ON after voltage of AC power or DC power is applied. (Not to be turned on upon remote operation of PD-6359A).

8. POWER SWITCH

This switch turns the power on and off.

Rear Panel

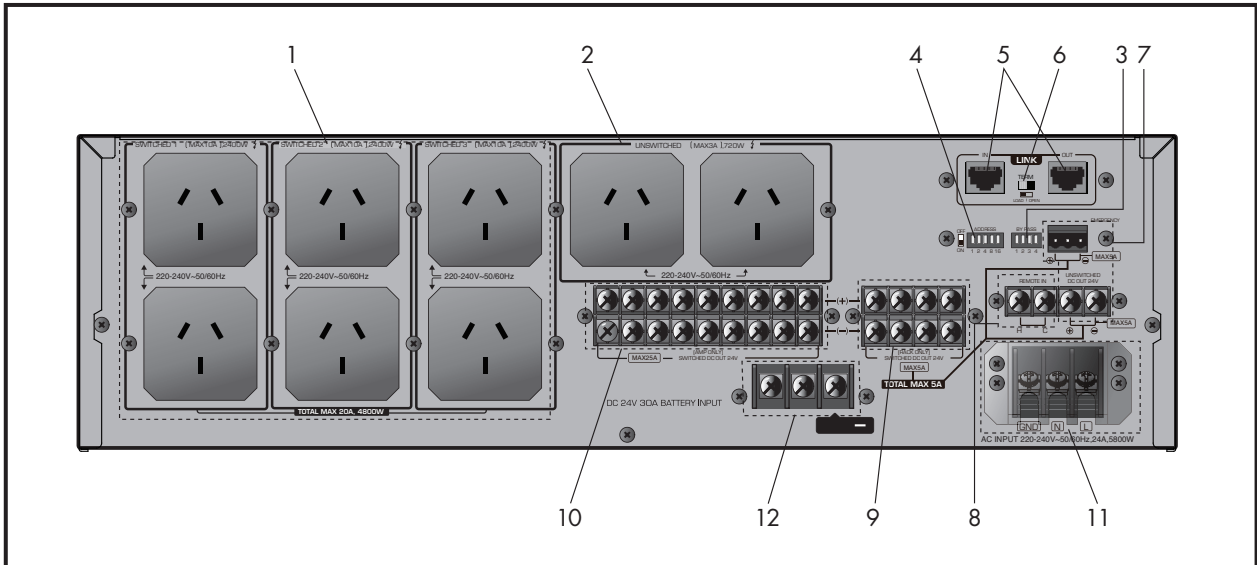

1. AC OUTLET (SWITCHED 1, 2, 3)

This is the AC power output terminal. AC power is output if the power switch in the front panel is pressed ON or activated remotely PD-6359A. AC power is to sequentially output according to the BY PASS setting switches, and please refer 3. BY PASS setting switch for detail explanation in this regard.

2. AC OUTLET (UNSWITCHED)

It is the terminal which AC power is supplied all the times, and it connects the devices which power should not be off.

3. BY PASS SETTING SWITCH

The switch that sets delay time upon which AC power at SWITCHED 1, 2, 3 is output in sequence. The setting method of delay time is referred to as the following table upon which AC power is to be output by the interval of delay time at SWITCHED 1, 2, 3. The order of output of AC Power is SWITCHED 3>SWITCHED 2> SWITCHED 1

Delay Time	DIP Switch			
	1	2	3	4
2 sec	OFF	OFF	OFF	OFF
1.5 sec	ON	OFF	OFF	OFF
1 sec	OFF	ON	OFF	OFF
0.5 sec	OFF	OFF	ON	OFF
BY PASS	OFF	OFF	OFF	ON

Ex) If BY PASS setting switch is all OFF position, then AC power is output from SWITCHED 3 and then after 2 sec., AC power is output from SWITCHED 2. At 2 sec later after AC power output from SWITCHED 2, then AC power is output from SWITCHED 1. If PD-6359A is turned off, AC power output stops in reverse order. If 3 of BY PASS setting switch is ON position, AC power is to output simultaneously from SWITCHED

※ If BY PASS setting switches are ON more than 2 switches then the front panel of BY PASS LED is to blink by 2 sec interval and AC power is to output by the order of SWITCHED 3 → SWITCHED 2 → SWITCHED 1. Please do not ON PASS setting switches more than 2 switches.

4. ADDRESS SWITCH

It is the switch setting up the device number. For the details of Equipment Setting, please refer to page 4.

5. LINK IN/OUT TERMINAL

It is the communication terminal for monitoring the status of service voltage. Link In terminal is connected to the previous device, and Link Out terminal will be connected to the next device.

※ Caution: Communication error may occur if setting is performed incorrectly.

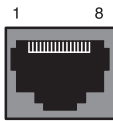

PIN NO.	Functions
1	RS-485 Data - A
2	RS-485 Data - B
3	RS-485 Data - Z
4	NA
5	GND
6	RS-485 Data - Y
7	NA
8	NA

※IN/OUT Terminals are all same.

6. TERMINATION SWITCH (LOAD/OPEN)

It is the switch which is set for stable data receiving/transmitting of link in/out.

For the details of Equipment Setting, please refer to page 4.

※Caution: communication error may occur if it is not set correctly.

7. DC POWER OUTPUT TERMINAL (UNSWITCHED)

It is the terminal which supplies the power to the device operated by DC 24V.

8. REMOTE TERMINAL

This is Remote Terminal to be remotely operated PD-6359A. Please connect PD terminal at rear panel of ECS-6216P our company's model. Upon a contact is output from PD terminal of ECS-6216P and upon a contact is input to remote terminal of PD-6359A then PD-6359A is to be operated automatically. Provided, the remote control can be operated only the power switch is OFF position in the front panel.

9. DC POWER OUTPUT TERMINAL (DC OUTPUT, ONLY RACK)

It is the terminal supplying DC power to the rack system as rated 24V power output. It can be controlled with front power switch ON/OFF.

10. DC POWER OUTPUT TERMINAL (DC OUTPUT, ONLY AMP)

It is the terminal which outputs the emergency DC power (Battery) in case of AC black out. Connect it to AMP DC INPUT.

11. AC INPUT TERMINAL

It is the terminal for connecting AC power. Do not bend, pull, twist, heat and cut by force. It may cause electric shock.

Power overloading may cause the power to be turned off automatically to protect the circuit of the equipment. Remove the cable connected to the DC power output terminal (UNSWITCHED, RACK ONLY), disconnect the power cable, and wait 10 seconds, and connect again.

12. DC 24V BATTERY INPUT TERMINAL (BATTERY INPUT)

It is the terminal which connects the emergency power to use the system in case of black out, and It normally connects to the battery. Caution to polarities when it connects.

Application

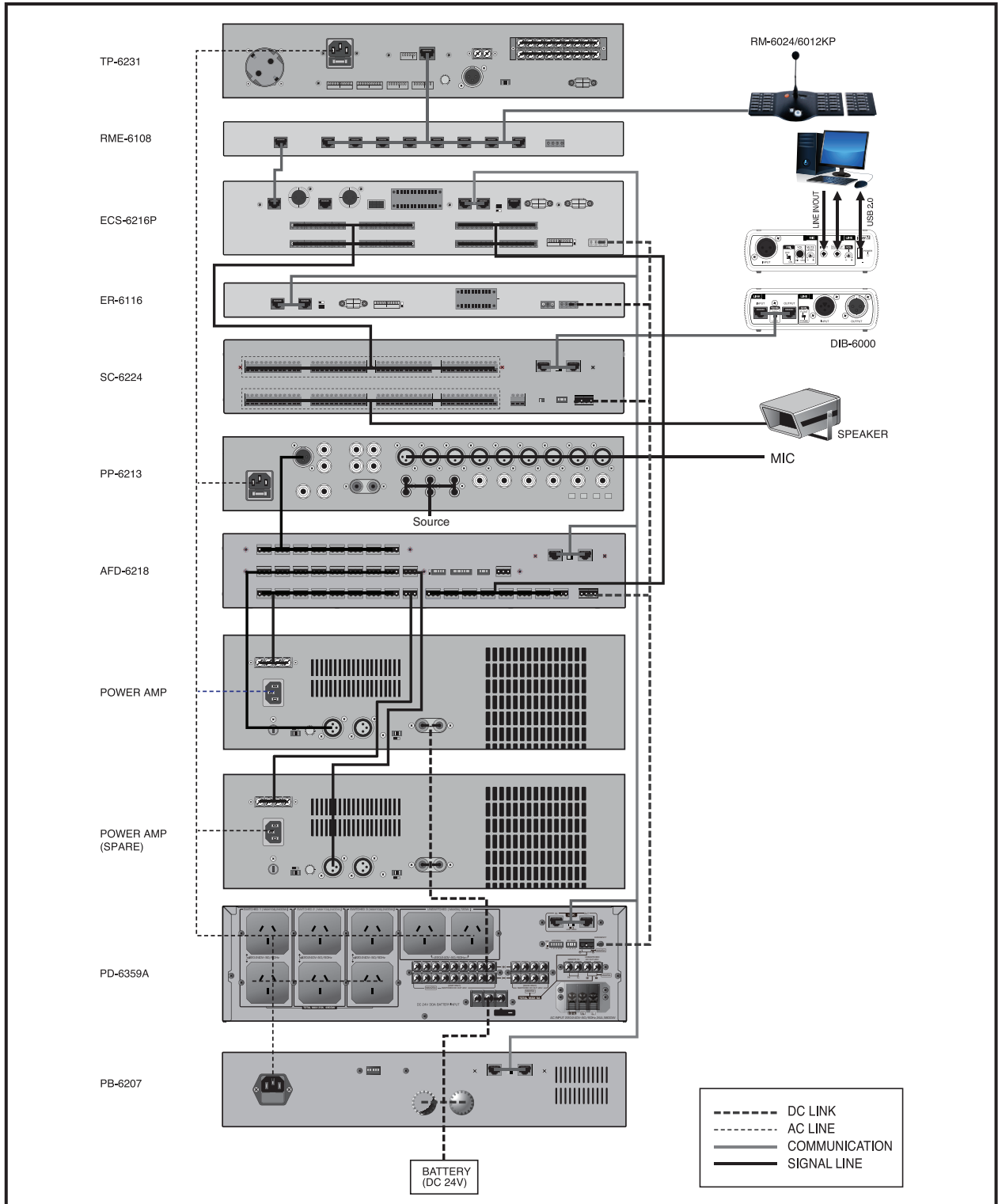

Block Diagram

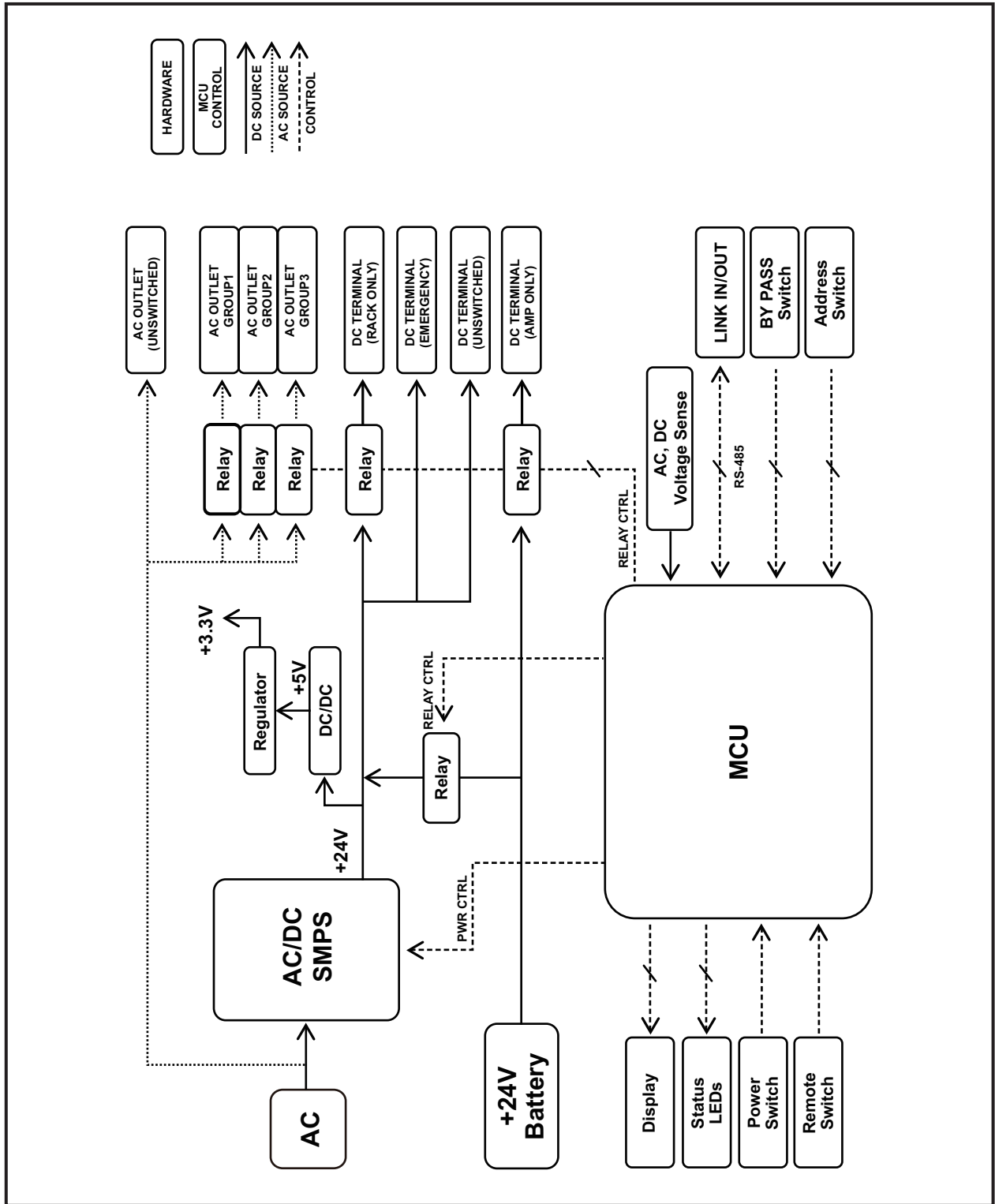

Specifications

	PD-6359A	
AC/DC Output	AC	SWITCHED: 10A, 3Group (3 Group × 3 = 9 channel) UNSWITCHED: 3A, 1Group (2 channel)
	DC	UNSWITCHED: 1 channel (24V, 5A Max) EMERGENCY: 1 channel (24V, 5A Max) AMP ONLY: 9 channel (24V, 25A Max) RACK ONLY: 4 channel (24V, 5A Max)
Sequential Power Delay	BY PASS ~ 2 sec (0.5 step)	
Communication	RS-485	
Operation Temperature	-10°C ~ 40°C	
Power Source	AC 220-240V, 50/60Hz	
Power Consumption	5.8kW	
Weight (SET)	5.8kg/12.8lb	
Dimensions (SET)	482(W)×132(H)×280(D)mm/18.98(W)×5.20(H)×11.02(D)in	

* Design and specification are subject to be changed for the improvement of product quality without pre notice.

※ DIMENSIONS

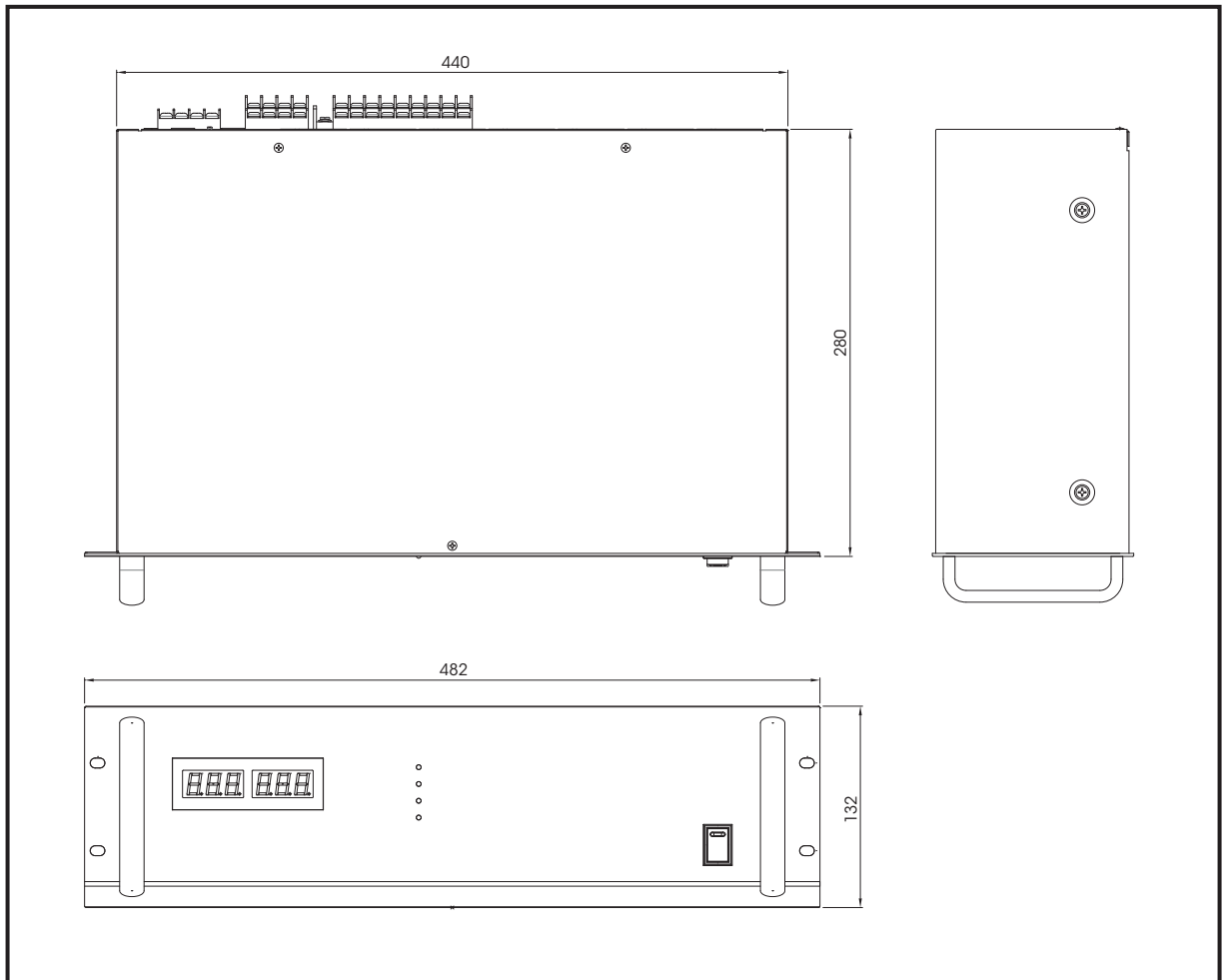

Service

Procedures

Take steps to insure the problem is not related to operator error or other products within the system. Information provided in the troubleshooting portion of this manual may help with this process. Once it is certain that the problem is related to the product contact your warranty provider as described in the warranty section of this manual.

Schematic

A Schematic is available by contacting your warranty provider.

Parts List

A Parts List is available by contacting your warranty provider.

Variations and Options

Variations

Products supplied through legitimate sources are compatible with local AC power requirements.

Options

No optional items are available for this product.

Warranty

Warranty terms and conditions vary by country and may not be the same for all products. Terms and conditions of warranty for a given product may be determined first by locating the appropriate country which the product was purchased in, then by locating the product type.

To obtain specific warranty information and available service locations contact Inter-M directly or the authorized Inter-M Distributor for your specific country or region.



Inter-M, Ltd. (Korea) began operations in 1983.

Since then, Inter-M has grown to become one of the largest manufacturers of professional audio and commercial sound electronics equipment in the world.

Inter-M has gained worldwide recognition for its own branded products, as well as private label manufacturing of electronics sold under other names (OEM).

The company is no longer just a Korean company, but rather a global company that is truly international in scope, with factories and offices in Korea and China, and sales and marketing operations located in Japan, Europe, and the U.S.A.

With more than 850 employees around the globe, Inter-M is well-poised for further growth and expansion.

Inter-M Americas, INC.

5666 CORPORATE AVE. CYPRESS, CA 90630
TEL : +1-714-828-2200, FAX : +1-714-828-2210
Home Page : <http://www.inter-m.net>, E-mail : info@inter-m.net

Inter-M Corporation

SEOUL OFFICE : 719, DOBONG-RO, DOBONG-GU, SEOUL, KOREA
TEL : +82-2-2289-8140~8, FAX : +82-2-2289-8149
Home Page : <http://www.inter-m.com>, E-mail : overseas@inter-m.com

MADE IN KOREA
July 2019 140672