

Unilumin

UHWII

**PRODUCT
MANUAL**

Narrow Pixel
Pitch LED Display



UNILUMIN GROUP CO.,LTD.

Revision Records

Version	Revised Content	Date
01	Initial release	July .25, 2019
02	Optimized installation	September .24, 2019
03	Add After-Sales and Warranty, Modify the control system part, Add module flatness adjustment Add Concave Installation	March 31, 2020

The manual may be modified without any prior notice.

Instructions

Thank you for choosing our product. Please read the Product Manual carefully before using the product. The manual may contain errors despite all our efforts, and may be subject to change without prior notice. Contact us if you have any questions or suggestion when using the manual. We will try our best to help you resolve the problems in time, and highly appreciate your suggestions.

Copyright

The manual is the property of Unilumin Group Co., Ltd. The Unilumin LED's operating software is developed based on the Windows operating system. No part of the manual can be transcribed, transmitted, reproduced, translated, edited, published, stored to a retrieval system, or used in any form by any individual or organization without a prior written permission of Unilumin.

Trademark

 is the registered trademark of Unilumin Group Co., Ltd.

Read the following content carefully to ensure correct use of the LED display products:

◆ WARNING!

The LED display may be damaged and become irreparable if you ignore the following warnings.

- 1) Do not place the LED display upside down or throw it during transport and storage.
- 2) Do not incline, scratch, or crash the LED display during installation.
- 3) Do not wet or submerge the LED display into water.
- 4) Do not direct the air outlet of an air conditioner to the LED display.
- 5) Do not place or use the LED display in an environment with volatile, corrosive or flammable chemical products.
- 6) Do not use the LED display outdoors in rainy days or when the humidity is higher than 80%.
- 7) Do not clean the LED display with water or chemical solvents.
- 8) Do not use any electrical accessories not approved by the equipment manufacturer.
- 9) Make sure the LED display and its auxiliary devices are grounded correctly and reliably before they are used.
- 10) Switch off the power immediately and contact the professional personnel when the LED display has any abnormal conditions such as peculiar smell, smoke, electric leakage, and abnormal temperature.

◆ **CAUTION!**

The optimum displaying effect may fail to be achieved if you ignore the following cautions.

- 1) Wear antistatic gloves when installing or repairing the product.
- 2) Ensure good ventilation for the LED display when designing the heat dissipation solution.
- 3) Keep the storage environment of the LED display well ventilated and dry, with a humidity not exceeding 85%.
- 4) Use single-phase power supply for an LED display with the total power consumption not exceeding 3 kW, and three-phase power supply for an LED display with the total power consumption exceeding 3 kW.
- 5) Ensure that the LED display is powered on at least twice per week, and at least 2 hours each time.
- 6) Installing the LED display in the following places may result in an equipment failure and reduce its lifespan: near the sea, in an area with salt and alkali or sulphurous gases, near a kitchen exhaust position, or at a place where the difference between indoor and outdoor temperatures is great. Consult our professional personnel at the service center if the LED display must be installed in any of these places.

Contents

Chapter 1 Product Introduction.....	1
1.1 Features.....	1
1.2 Cabinet Appearance	2
1.3 Specification.....	3
1.4 System Solution	4
1.5 Scope of Application	5
Chapter 2 Installation and Wiring	6
2.1 Out-of-Box Inspection	6
2.2 General Installation	6
2.2.1 Installation of Fixed LED Display-Front Installation (Standard).....	7
2.2.2 Installation of Fixed LED Display- Rear Installation (Optional)	9
2.3 Module Flatness Adjustment.....	16
2.3.1 Module Flatness Adjustment	16
2.4 Wiring for LED Display	17
2.4.1 Common Cables	17
2.4.2 Signal Cable Connection	18
2.4.3 Power Cable Connection	20
2.4.4 Smart Control Distribution Box	22
Chapter 3 LED Display Control Setting.....	24
3.1 Power-on Testing	24
3.2 Starting the Hardware	25
3.3 Unilumin N series - Software Control Setting	25
3.3.1 Installing the Software.....	25
3.3.2 Display Configuration	26
3.3.3 Brightness Adjustment.....	30
3.3.4 Correction Coefficient Management.....	32
3.3.4.1 Setting Coefficients for a New Receiving Card	34
3.3.4.2 Setting Coefficients for a New Module	37
3.3.4.3 Replace Module with Flash.....	39
3.3.5 Pre-storing Picture	40

3.4 Unilumin K series - Software Control Setting.....	42
3.4.1 Installing the Software	42
3.4.2 Display Configuration	42
3.4.2.1 Login to the Display Settings Interface.....	42
3.4.2.2 Set the Sending Card	43
3.4.2.3 Screen Parameters Setting.....	46
3.4.2.4 Display Connection	47
3.4.3 Brightness Adjustment.....	47
3.4.4 Calibration.....	50
3.4.4.1 Setting Coefficients for a New Module	50
Chapter 4 LED Display Playing Setting.....	54
4.1 Unilumin N series - LED Display Playing Setting.....	54
4.1.1 Selecting a Playing Solution	54
4.1.2 Playing Setting.....	55
4.1.2.1 Display Window Setting.....	55
4.1.2.2 Startup Setting.....	56
4.1.3 Editing Professional Playing Solution	57
4.1.3.1 Editing the Time Segment.....	57
4.1.3.2 Editing the Program Page.....	59
4.1.3.3 Editing the Display Window	62
4.1.3.4 Editing the Media.....	65
4.1.3.5 Playing the Media.....	68
4.1.4 Saving and Opening a Playing Solution	70
4.2 Unilumin K series - LED Display Playing Setting.....	72
4.2.1 Set the Count and Size of the Screen	72
4.2.2 Setting the Program Page	73
4.2.3 Adjust Window Position and Size	76
4.2.4 Playing the Program	77
4.2.5 Edit Window.....	79
4.2.6 Timed Playback and Control.....	80
Chapter 5 Startup, Shutdown, and Maintenance	83
5.1 Startup Sequence	83

5.2 Shutdown Sequence	83
5.3 Daily Maintenance	83
5.4 Warm-up Operation.....	84
5.4.1 Unilumin N series - Setting the Prestored Picture	84
5.4.2 Unilumin N series - Ageing Operation	85
5.4.3 Unilumin K series - Ageing Operation	87
Chapter 6 Troubleshooting and Component Replacement	88
6.1 Common Faults and Troubleshooting Methods	88
6.1.1 Failure in Lighting up the Display	88
6.1.2 Incomplete Picture or Incorrect Position of Picture Displayed	88
6.1.3 Screen Blinking.....	89
6.1.4 Blinking of a Cabinet in the Display.....	89
6.1.5 Failure in Lighting up of a Cabinet in the Display	89
6.1.6 Failure in Lighting up Part of the Modules in the Cabinet	90
6.2 Replacement of Main Components	90
6.2.1 Replacement of Module.....	90
6.2.2 Replacement of Power Supply	92
6.2.3 Replacement of Receiving Card.....	94
Chapter 7 Packaging Transportation and Storage	96
7.1 Packaging	96
7.2 Transportation	96
7.3 Storage.....	96
Chapter 8 After-Sales and Warranty	97
8.1 Warranty Scope	97
8.2 Warranty Period	97
8.3 Warranty Service.....	97
8.3.1 Warranty Service Types.....	97
8.4 Disclaimer	98
8.5 Warranty Service Process.....	99
8.6 Other	100
8.7 Product Warranty Card	101
Attachment 1 - Path of Signal Cable inside the Cabinet	102

Contact Information 错误!未定义书签。

Unilumin

Chapter 1 Product Introduction

The UHWII series is a new generation of small pitch LED display product launched by Unilumin. Designed for HD display application scenarios, the UHWII series has a standard aspect ratio of 16:9 and has achieved perfect match between video signals and display terminals. With excellent colour reproduction, stable pictures, and wide viewing angle, the UHWII series supports wide-range adjustment of the colour temperature and brightness. The pixel-by-pixel calibration technology can greatly improve experience of using the UHWII series product in projects. Outstanding safety design of the UHWII series delivers prominent safety performance, high protection level, and high reliability. Freely and seamlessly spliced into any size display to meet the needs of the application environment.

1.1 Features

- 1) Aspect ratio of 16:9, pixel to pixel full HD display, and can be assembled into a 2K, 4K, or 8K standard HD screen.
- 2) Ultrathin, lightweight, and highly stable aluminium die casting structure. protection level up to IP60.
- 3) Supports front maintenance on the modules, power supplies, and receiving cards.
- 4) Wide colour gamut, and adjustable brightness and colour temperature.

1.2 Cabinet Appearance

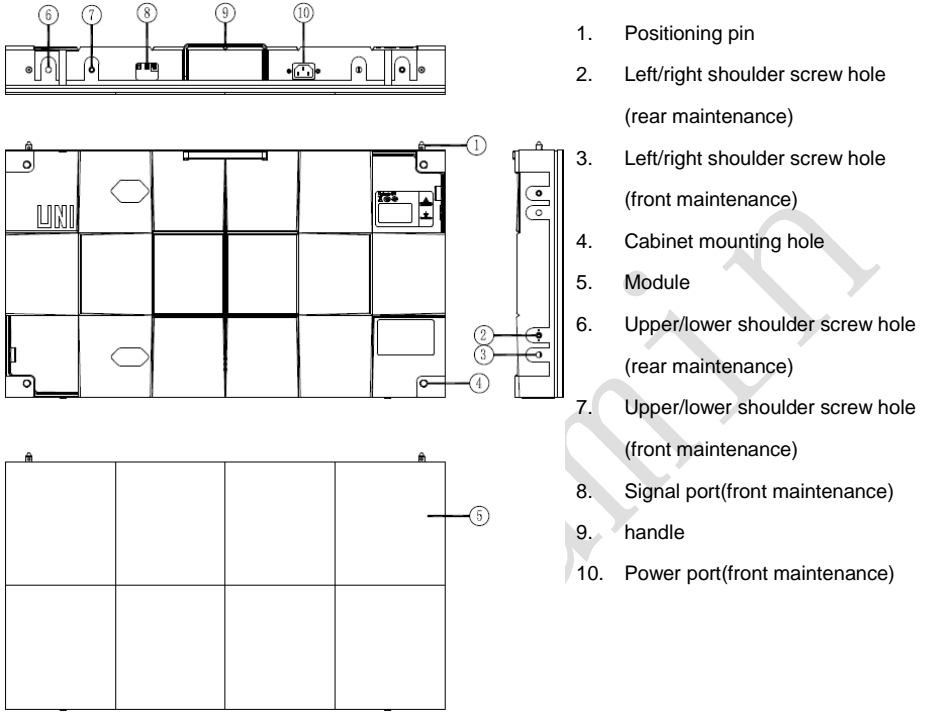

Fig 1-1 Cabinet Appearance

1.3 Specification

Parameter		UHWII1.2	UHWII1.5	UHWII1.9	UHWII2.5
Physical Parameter	Pixel composition	1R1G1B			
	LED type	3-in-1 Black SMD			
	Pixels per panel(dots)	480x270	384x216	320x180	240x135
	Cabinet size (WxHxD) (mm)	609.92x343.08x68			
	Size ratio	16:9			
	Material	Die-casting aluminum			
	Planeness(mm)	≤0.15			
	Weight(kg)	7			
	Refresh rate(Hz)	1920			
	Frame frequency(Hz)	50/60			
	Data interconnection	Signal cable≤100m; Multi-mode fiber≤300m; Single-mode fiber≤10km			
Optical parameter	Brightness(nits)	600		800	
	Color temperature(K)	2,000~9,500 (adjustable)			
	Viewing angle(°)	160/160		140/140	
Electrical parameter	Input voltage(V)	AC 100~240			
	Input frequency(Hz)	50~60			
	Input power <max >(W/panel)	140±15		120±15	
	Input power < typical >(W/panel)	46±15		40±15	
Circumstance parameter	Storage temperature/ Humidity(°C/RH)	-20~+55/10%~85%			
	Working temperature/ Humidity(°C/RH)	-10~+45/10%~80%			

Note: Specifications are for reference only and are subject to change without notice.

1.4 System Solution

The display system consists of the LED display, sending box, control PC, matrix, splicing controller and power distribution box (refer to the shipping list for details). The following shows a topology of the system for reference:

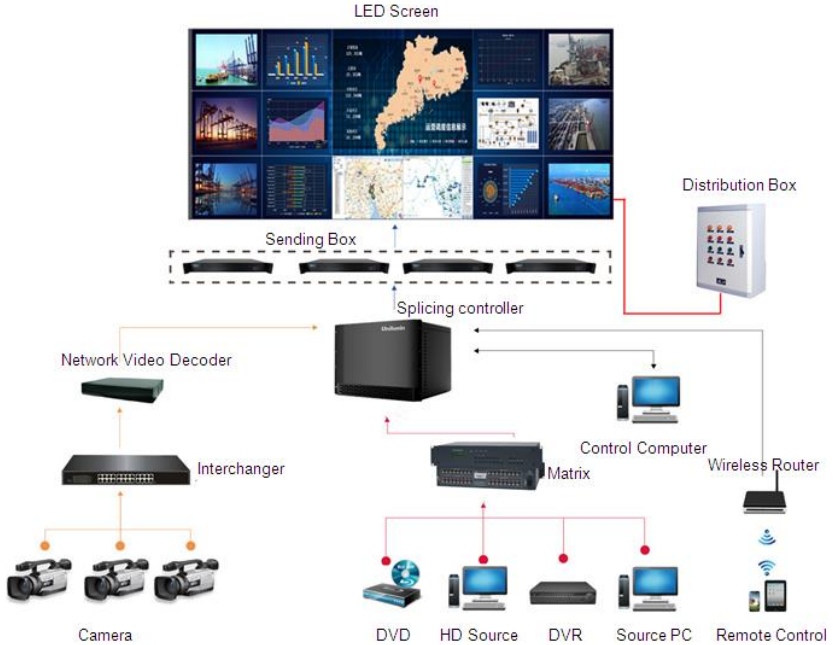

Fig 1-2 System Topology

1.5 Scope of Application

The UHWII series products can be assembled seamlessly into a screen of any size, and are extensively used as fixed LED displays for advertisements in public places such as retail brand stores, shopping malls, hotels, banks, churches, airports, bus stations, theatres, cinemas, company lobbies, and conference rooms.



Conference Center



Lobby

Chapter 2 Installation and Wiring

2.1 Out-of-Box Inspection

Check whether the packages are damaged. If the packages are intact, check the main components against the shipping list. If any inconsistency is found, contact us in time.

The main components include cabinets, signal cable, power cable, USB cable, DVI cable, and sending box. For details about the components, refer to the shipping list.

2.2 General Installation

Screen calibration is performed on the UHWII series product before shipment, and the product needs to be installed sequentially according to the cabinet number, as shown in Figure 2-1:

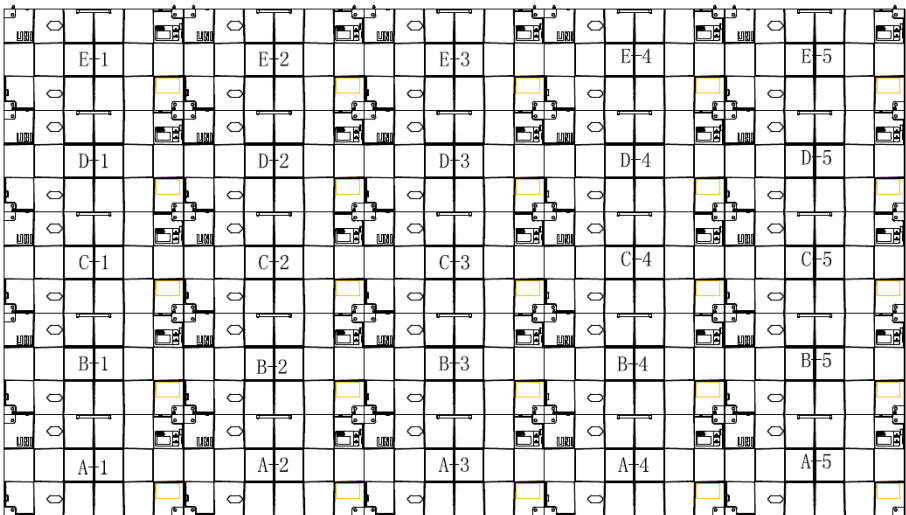

Fig 2-1 Rear View of the Display

2.2.1 Installation of Fixed LED Display-Front Installation (Standard)

- 1) Check whether the aluminium profile installation is level. Make sure that its levelness is within $\pm 1\text{mm}$.
- 2) Install the cabinets sequentially from bottom to top and from middle to both sides. Fasten the adjacent cabinets with screws. In addition, secure the mounting plates and cabinets with socket head cap screws.
- 3) Keep flatness between the cabinets during cabinet installation
- 4) After the installation of the cabinet is completed, Connect the power cable and the signal cable between the cabinets;
- 5) Install the module on the corresponding cabinets. The installation number of the single cabinet module is shown in Figure 2-5. During the module installation keep flatness between the modules during modules installation.
- 6) The installation of the screen is completed

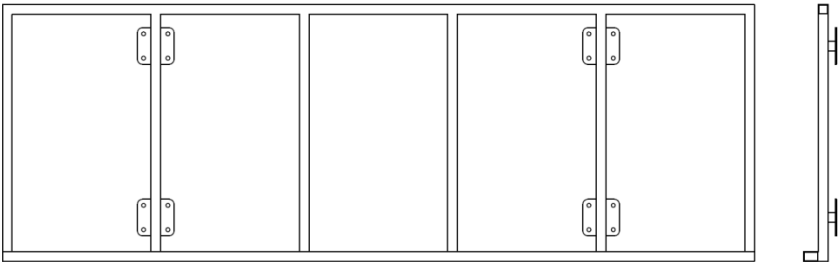

Fig 2-2 Profile Installation

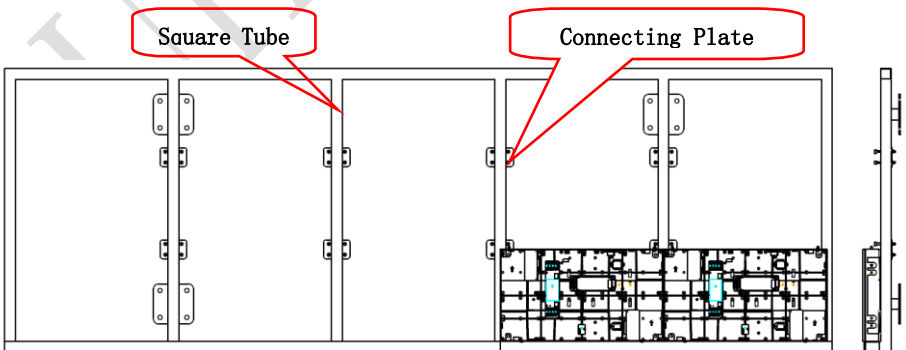

Fig 2-3 Cabinet Fastening

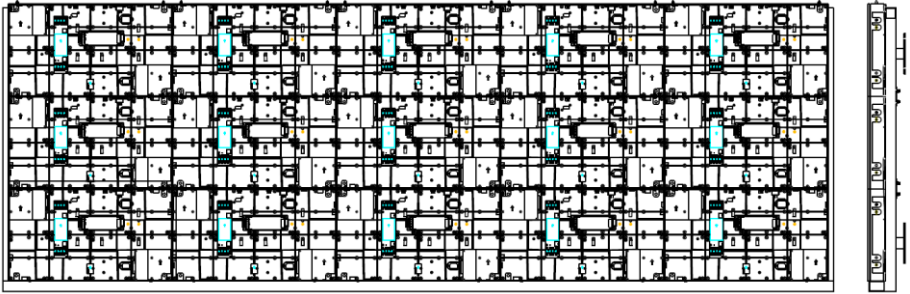

Fig 2-4 Front View of Cabinet Installation

1	2	3	4
5	6	7	8

Fig 2-5 Front View of Single Cabinet Module Number

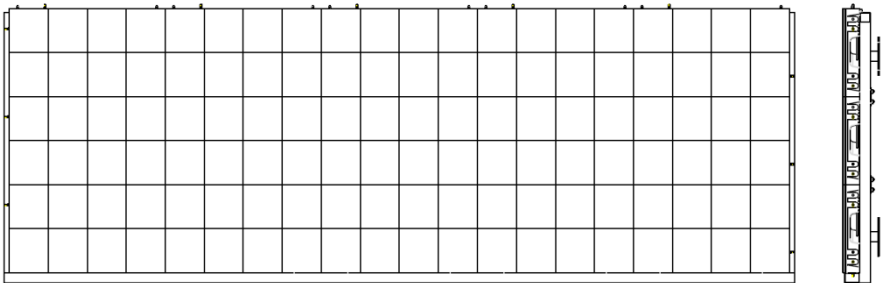

Fig 2-6 Front View of the Display

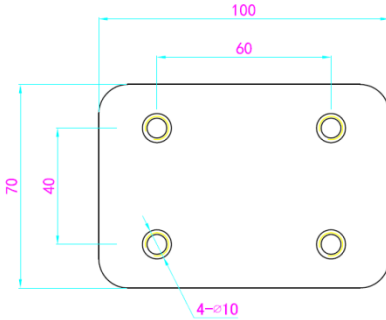

Figure 2-7 Front Connecting Plate
(Front View)

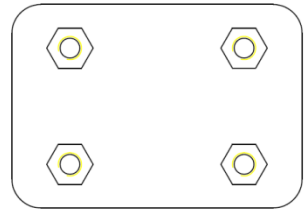

Figure 2-8 Front Connecting Plate
(Rear View)



Fig 2-9 M8 x 70 socket head cap screws (front)

2.2.2 Installation of Fixed LED Display- Rear Installation (Optional)

- 1) Check whether the bottom beam is level. Make sure that its levelness is within $\pm 1\text{mm}$.
- 2) Install the cabinets sequentially from bottom to top and from middle to both sides. Fasten the adjacent cabinets with screws. In addition, secure the mounting plates and cabinets with socket head cap screws to the square tubes.
- 3) Keep flatness between the cabinets during cabinet installation
- 4) The installation of the screen is completed

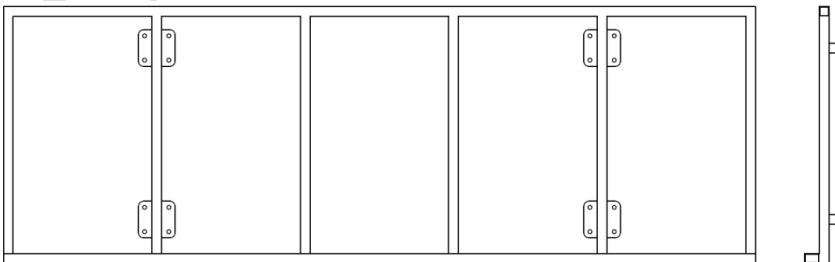

Fig 2-10 Profile Installation

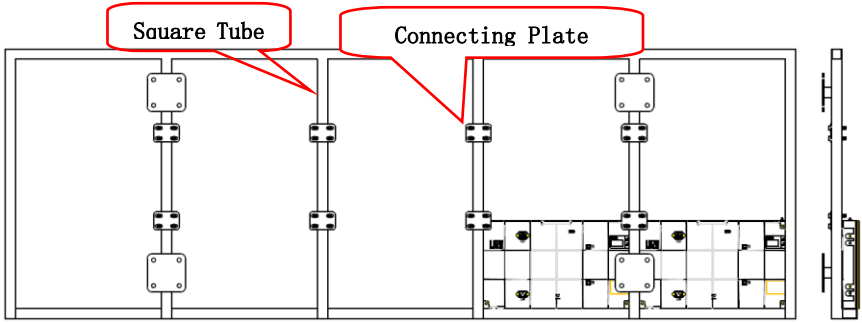

Fig 2-11 Cabinet Fastening

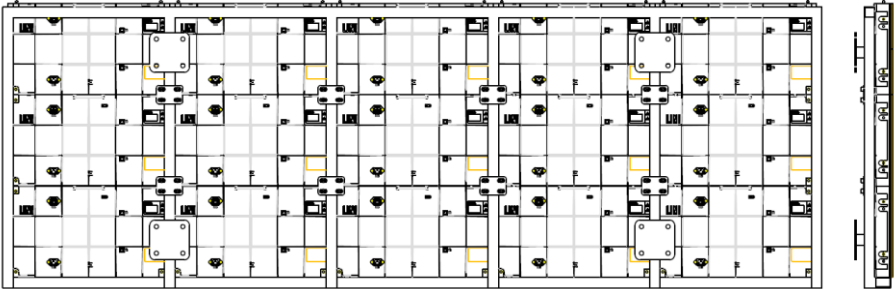

Fig 2-12 Rear View of the Display

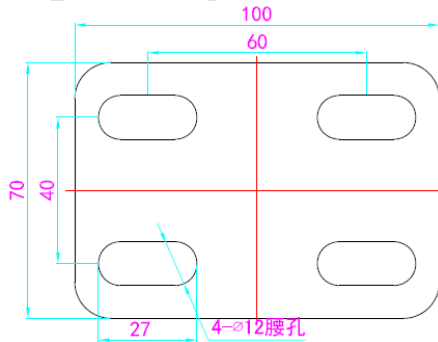

Fig 2-13 Rear Connecting Plate (front)



Fig 2-14 M10 x 60 socket head cap screws (rear)

2.2.3 Concave Installation (0°—2°)

- 1) Make sure that the bottom beam is horizontal, and the value is within $\pm 1\text{mm}$;
- 2) Assemble the specific trimming cabinet from the bottom to the top and from the middle to both sides successively;
- 3) The left and right cabinets are fixed with left and right shoulder screw, and the mounting plate and cabinets are fixed on the square pipe with hexagon socket bolts;
- 4) After the first line of cabinet is installed, the second line of cabinet is installed, and the upper and lower cabinets are fixed with upper and lower shoulder screw;
- 5) In the process of cabinet installation, it is necessary to pay attention to the gap and flatness between cabinets.

Note:

- 1) The concave installation within 2 ° does not use angle block, but uses special trimming cabinet for installation. During installation, pay attention to adjust the gap and flatness between cabinets.
- 2) Rear installation recommended for Concave splicing.

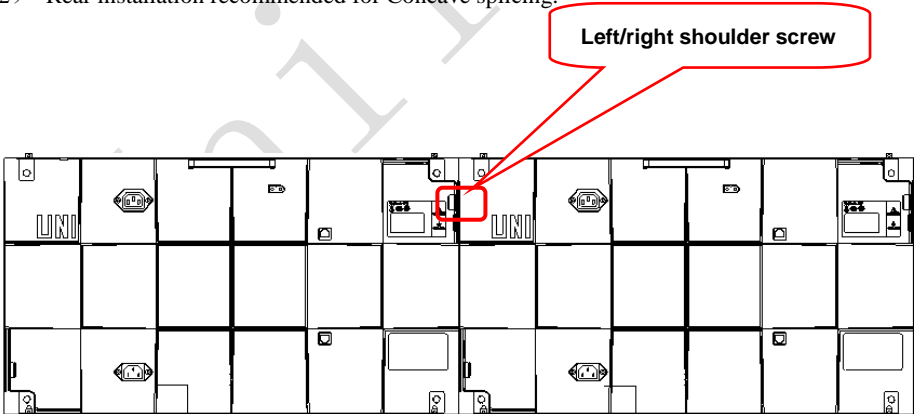

Fig 2-15 Locking of left and right cabinets completed

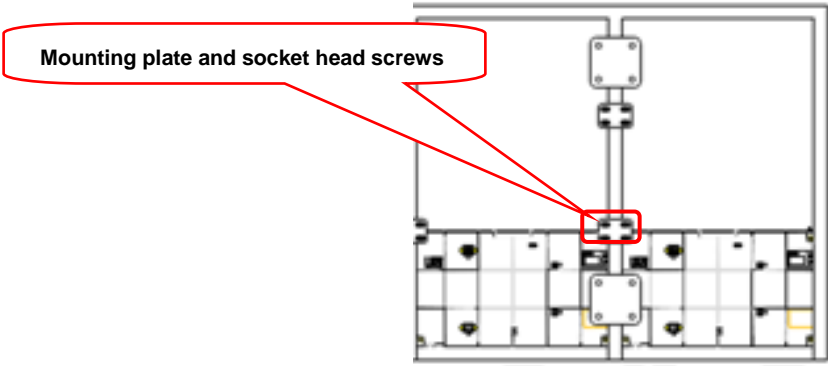

Fig 2-16 Upper and lower cabinet locked

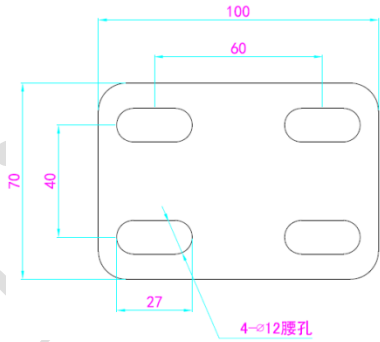

Fig 2-17 Rear Connecting Plate (front)

2.2.4 Concave Installation ($\geq 2^\circ$)

- 1) Make sure that the bottom beam is horizontal, and the value is within $\pm 1\text{mm}$;
- 2) Assemble the cabinet from the bottom to the top, from the middle to both sides. Fix the angle block on the screw hole on the right side of the cabinet with $\text{KM}2 \times 6$ screw, as shown in Fig. 2-19 and Fig. 2-20;
- 3) The left and right cabinets are fixed with M6 plug bolts, as shown in Fig. 2-23; the mounting plate and cabinet are fixed on the square pipe with hexagon socket bolts;
- 4) After the first line of cabinet is installed, install the second line of cabinet, and fix the upper and lower cabinets with upper and lower plug bolts, as shown in Figure 2-25;
- 5) In the process of cabinet installation, it is necessary to pay attention to the gap and flatness between cabinets.

Note: Rear installation recommended for Concave splicing.

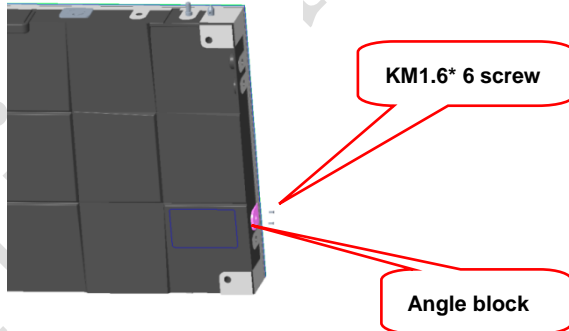

Fig 2-18 Installing angle block 1

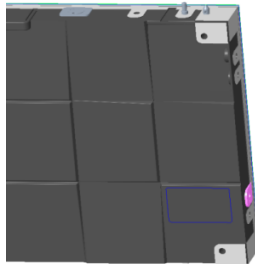

Fig 2-19 Installing angle block 2

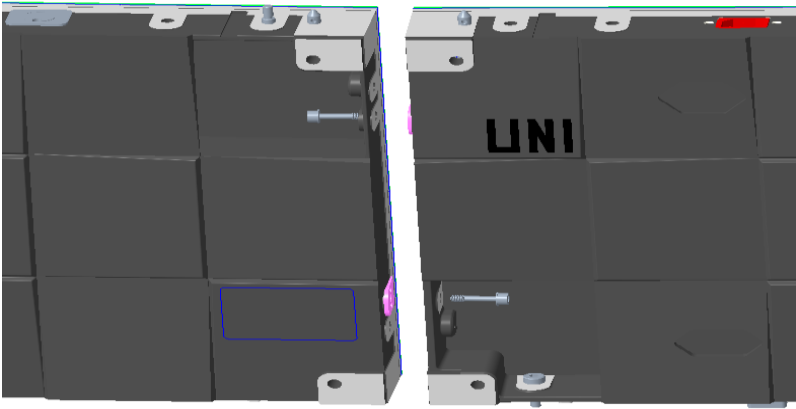

Fig 2-20 Splicing of left and right cabinet s

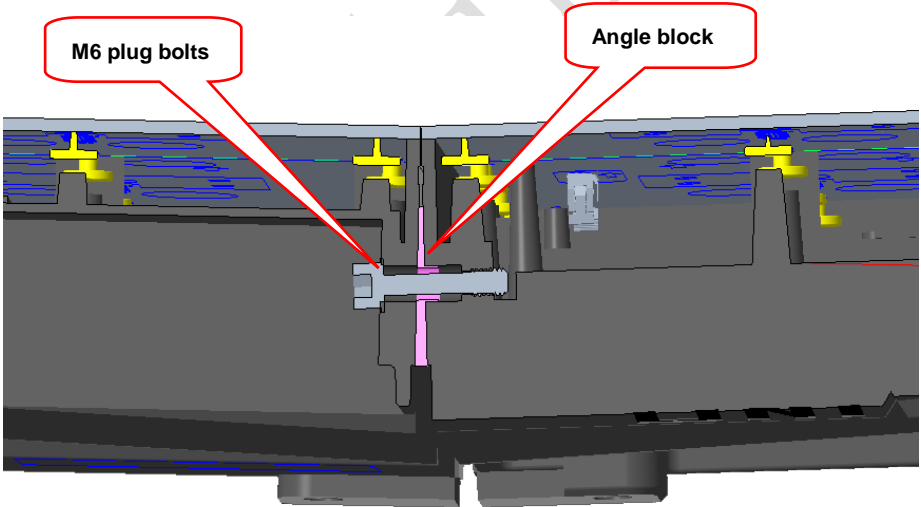

Fig 2-21 Internal drawing of left and right cabinet splicing

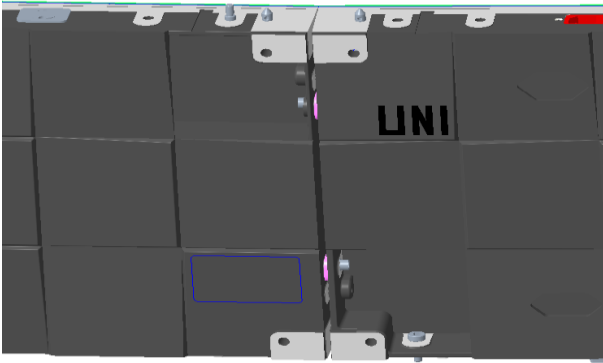

Fig 2-22 Splicing of left and right cabinets completed

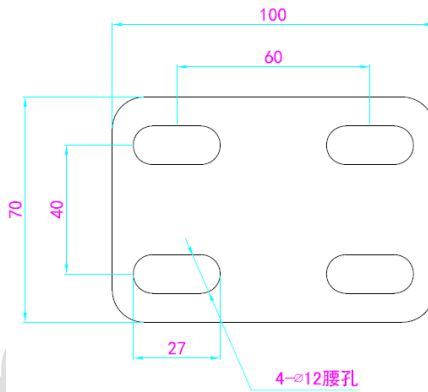

Fig 2-23 Rear Connecting Plate (front)

2.3 Module Flatness Adjustment

2.3.1 Module Flatness Adjustment

When there is a deviation in flatness between adjacent modules, use the adjustment tool to adjust the magnet on the box. At the low end, the module regulates the adjustable magnets until the module is flush with the adjacent modules. (one module has 9 adjustable magnets)

Specification of adjusting magnet: $D10 * 3 + m3 * 5$



Fig 2-24 Adjustable magnet

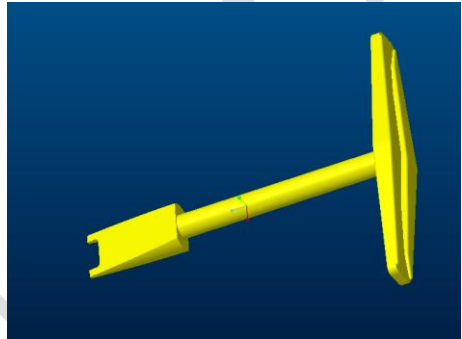

Fig 2-25 Adjusting tool

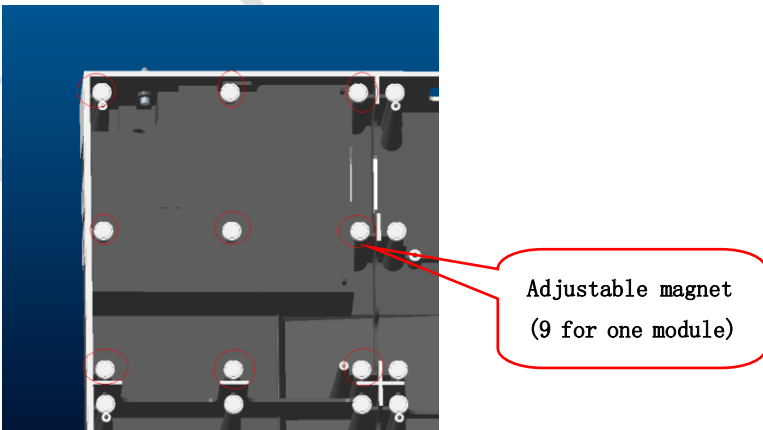

Fig 2-26 Schematic diagram of adjustable magnet

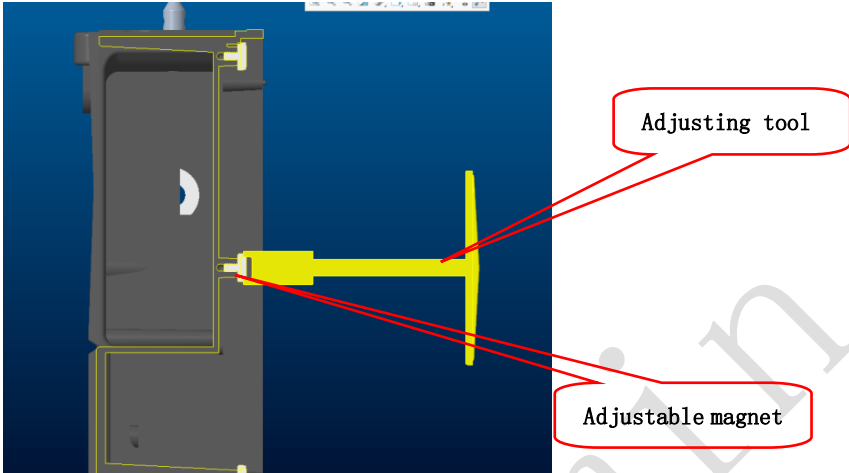

Fig 2-27 Schematic diagram of module flatness adjustment

2.4 Wiring for LED Display

2.4.1 Common Cables



Incoming Power Cables



Power Cable Passing Through Cabinet



DVI Cable



Incoming Signal Cable



USB Cable

2.4.2 Signal Cable Connection

Figure 2-30 ~ Figure 2-33 shows the signal cable connection for display with a resolution of 1920 x 1090. Signal cables shall be connected based on the wiring diagram of the delivered products for the project.

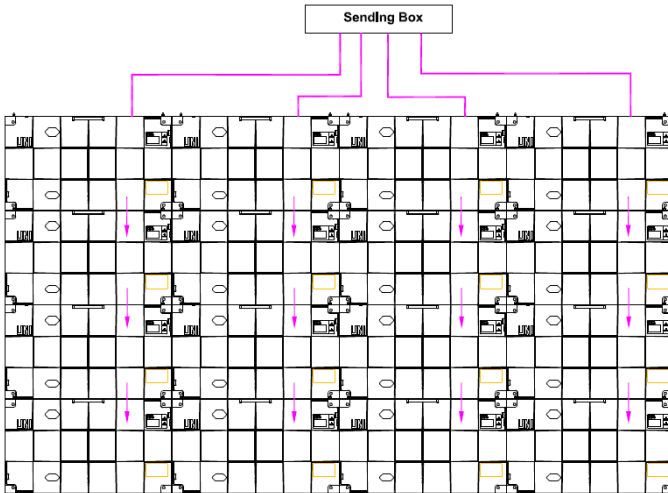

Fig 2-28 Signal Cable Connection Diagram of UHW11 1.2

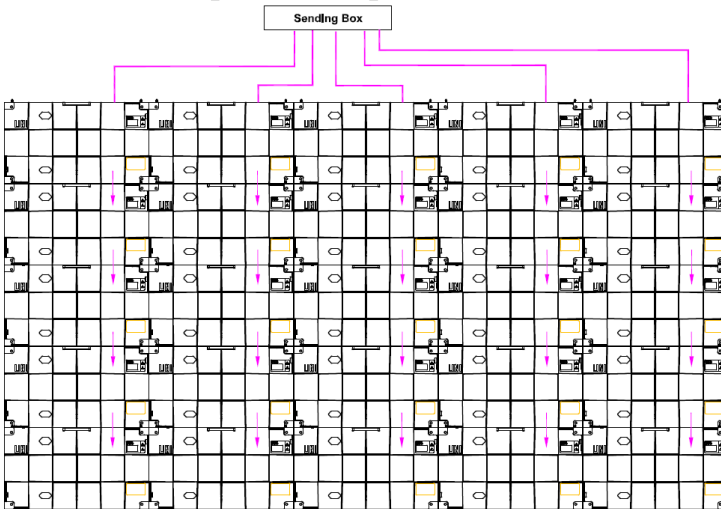

Fig 2-29 Signal Cable Connection Diagram of UHW11 1.5

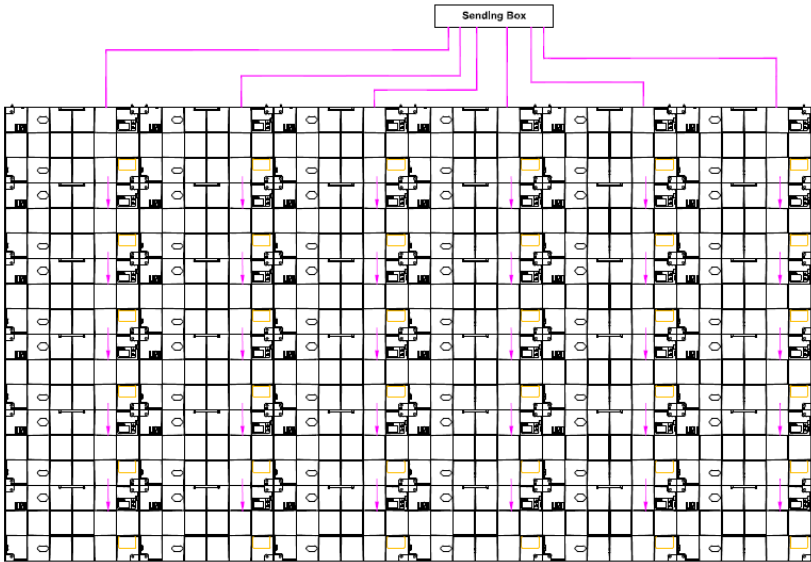

Fig 2-30 Signal Cable Connection Diagram of UHWII 1.9

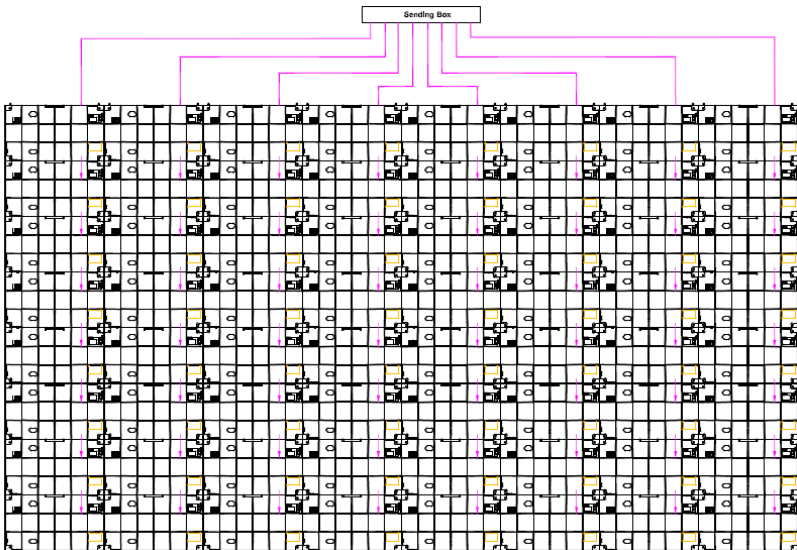

Fig 2-31 Signal Cable Connection Diagram of UHWII 2.5

2.4.3 Power Cable Connection

Figure 2-34 ~ Figure 2-37 shows the power cable connection for display with a resolution of 1920 x 1090. Power cables shall be connected based on the wiring diagram of the delivered products for the project.

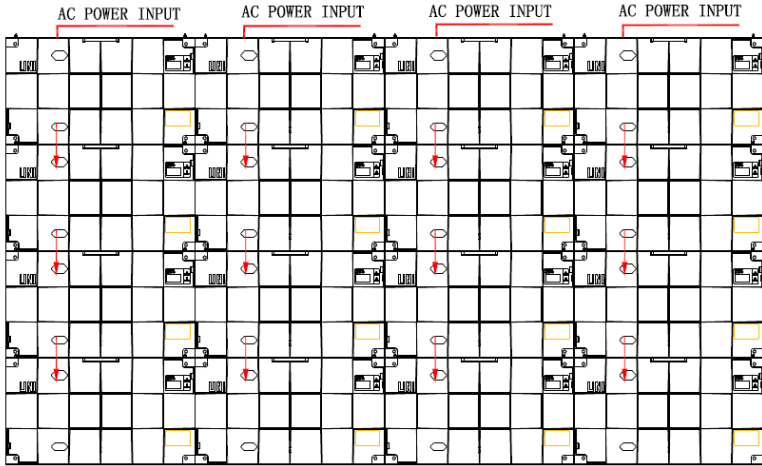

Fig 2-32 Power Cable Connection Diagram of UHWII 1.2

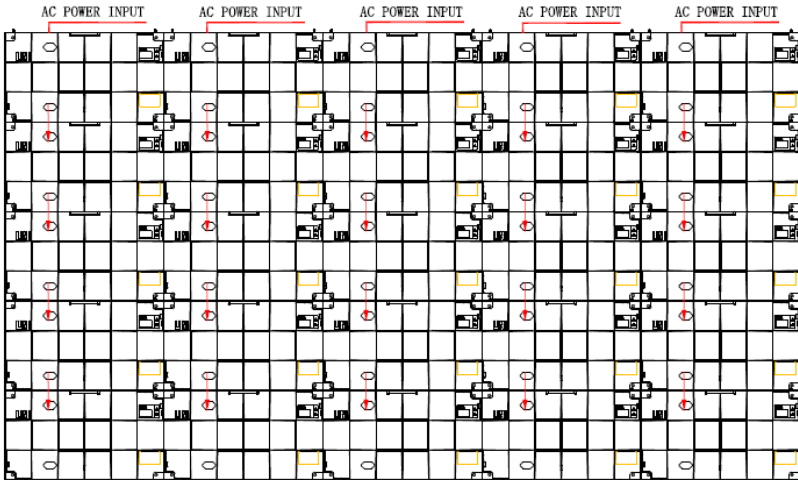

Fig 2-33 Power Cable Connection Diagram of UHWII 1.5

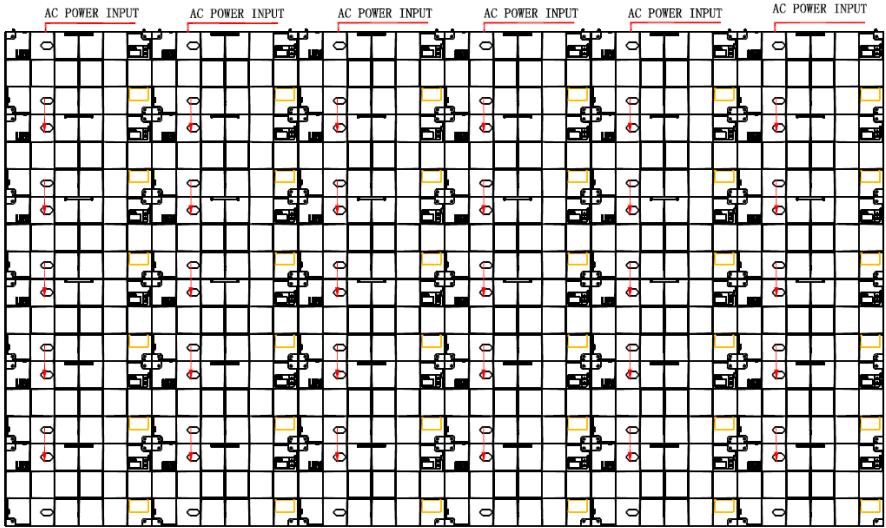

Fig 2-34 Power Cable Connection Diagram of UHWII 1.9

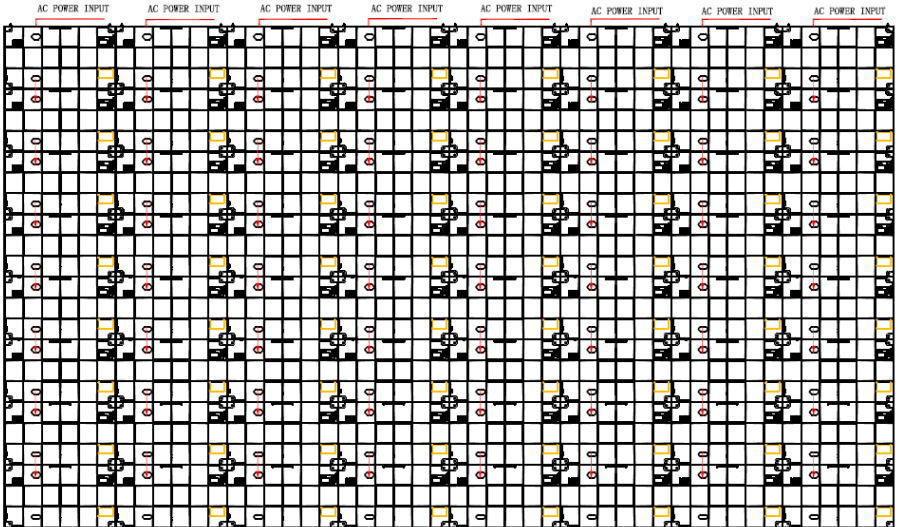

Fig 2-35 Power Cable Connection Diagram of UHWII 2.5

2.4.4 Smart Control Distribution Box

The Smart Control Distribution Box can be used for distributing electric power to the LED display, and has the function for real-time monitoring of the temperature, humidity, smoke, and mains voltage of the external environment. The control software has the scheduled start/stop function, allowing you to set any time for the LED display to be remotely started or stopped.

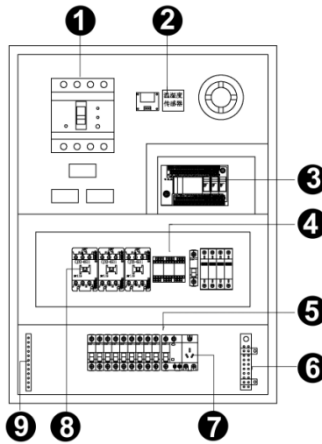

Fig 2-36 Internal Structure of Distribution Box

SN	Component	Remark (s)
1	Main switch	MCCB
2	Temperature sensor	Used for temperature detection
3	PLC	Used for smart control
4	Relays	Used to control the ON/OFF of the AC contactor
5	Circuit breaker	MCB , Connect to display live wire
6	Neutral wire socket	Connect neutral wire
7	Power Port	/
8	AC Contactor	Used to control the ON/OFF of the current
9	Earth wire socket	Connect earth wire

PLC connection of the smart control distribution box:

The PLC communication system is RS485, It uses converter from control computer RS232 to RS485. For more detail information, please refer to our Intelligent Power Distribution Management System Manual.

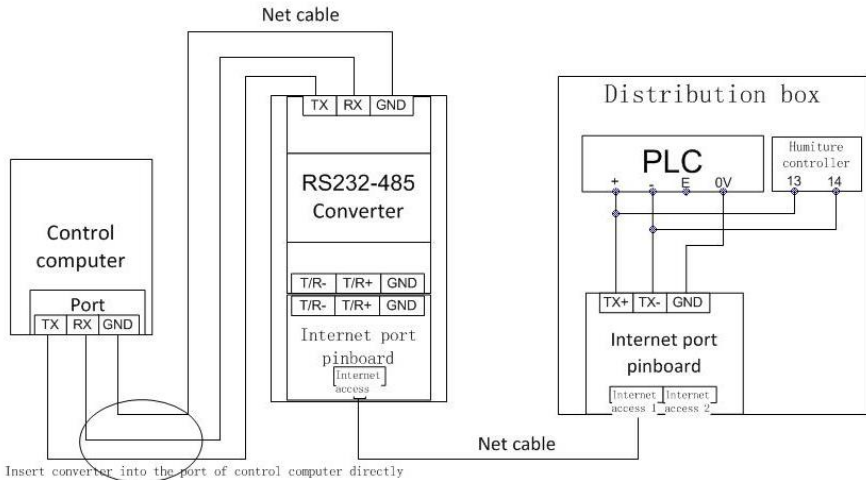

Fig 2-37 Distribution Box PLC Connection Diagram

Chapter 3 LED Display Control Setting

3.1 Power-on Testing

Before performing control setting on the LED display, confirm that each device is connected correctly.

- 1) Before turning on the power of the LED display, you must use a multimeter to test the live wire, neutral wire, and ground wire of the AC power supply, in order to ensure they are not conductive with each other.
- 2) The ground wire must be in reliable contact with the ground, and kept away properly from the live wire. The connected power supply shall be distant from high-power equipment.
- 3) When the 3-phase and 5-wire system is adopted, the load shall be distributed evenly among the phases to ensure three-phase balance as far as possible.
- 4) The input voltage must meet the voltage requirements indicated the cabinet rating label.
- 5) Connect the USB cable provided for the sending box to the USB port on the control PC.
- 6) Check whether cables for the LED display are connected in accordance with the power cable and signal cable connection diagrams provided for the delivered products.

3.2 Starting the Hardware

Start the control PC Windows system. After the graphics card driver is activated, set graphics card of the control PC to replication mode and confirm that the green indicator of the sending box is blinking normally (blinking once per second).

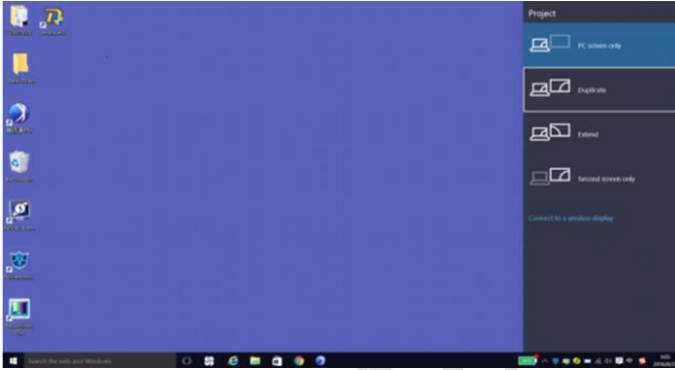

Fig 3-1 Replication Mode

3.3 Unilumin N series - Software Control Setting

3.3.1 Installing the Software

- 7) Open the optical disk provided for the delivered products. Install the LED control software UniLCT-Mars stored in the optical disk to the control PC. Then install UniStudio.



Fig 3-2 Software Installation

NOTE: You can follow the software installation wizard to install the software.

3.3.2 Display Configuration

Run UniLCT-Mars. Make sure that **Control System** on the main window is 1. Click the **User** option and select **Advanced Login**, as shown in Figure 3-3.

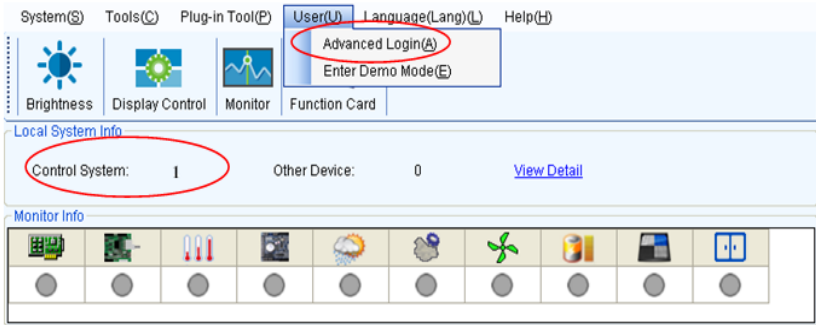

Fig 3-3 Main Window of UniLCT-Mars

Enter the initial password “admin”, as shown in Figure 3-4, to go to the advanced user window.

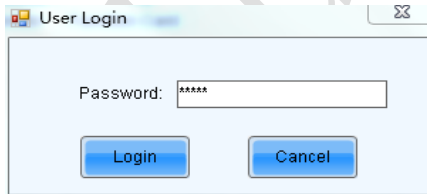

Fig 3-4 User Login

After login, click **Screen Config** on the main window, as shown in Figure 3-5:

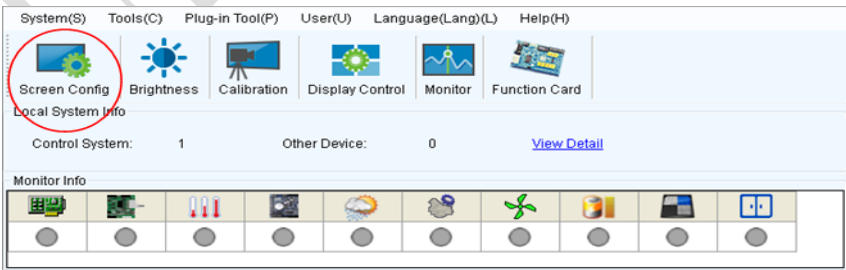

Fig 3-5 Main Window for Advanced User

Click **Next**, as shown in Figure 3-6:

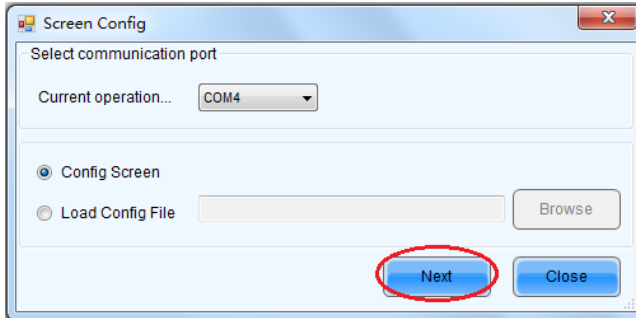

Fig 3-6 Screen Configuration

The following window is displayed. Set **Sending Board Resolution** (1920×1080 recommended). Set **Graphics Output Resolution** to the same value as **Sending Board Resolution**. Then click **Save** to save the settings.

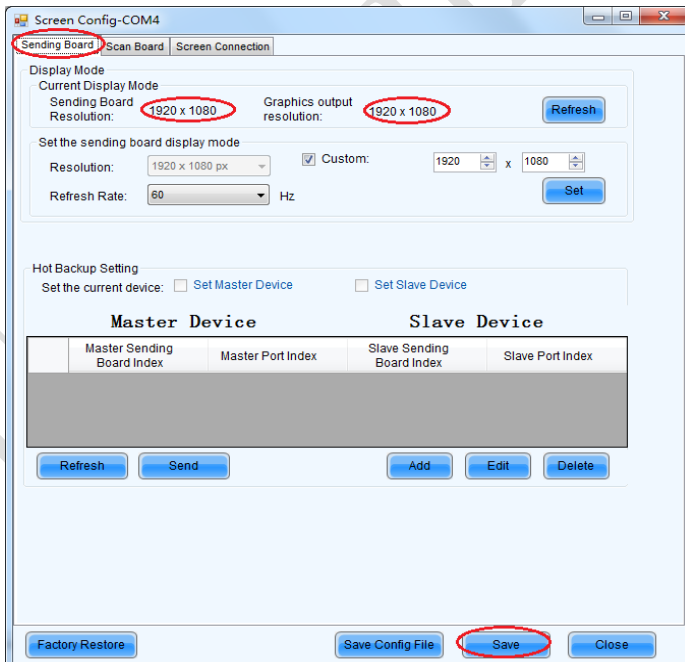

Fig 3-7 Sending Board Configuration

After configuring the parameters on the **Sending Board** page, click **Scan Board** to display the following window:

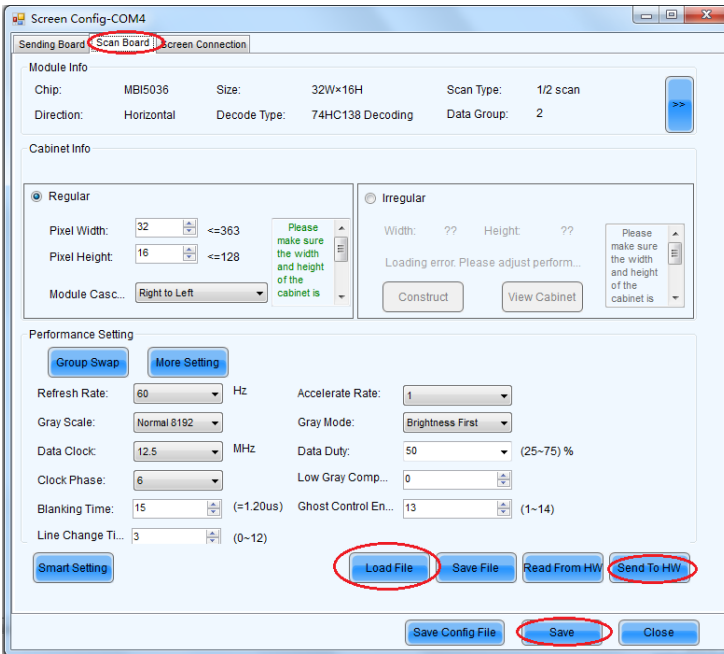

Fig 3-8 Scan Board Configuration

- 1) Click **Load File** to load the file xxx.rcfg stored in the optical disk.
- 2) Click **Send to HW**.
- 3) After sending, confirm that the loaded picture received by scan board is normal on the screen. Then click **Save**.

After configuring the parameters on the **Scan Board** page, click **Screen Connection** to display the following window:

- 1) Click **Read File** to load the file xxxx.scr stored in the optical disk, as shown in Figure 3-9.

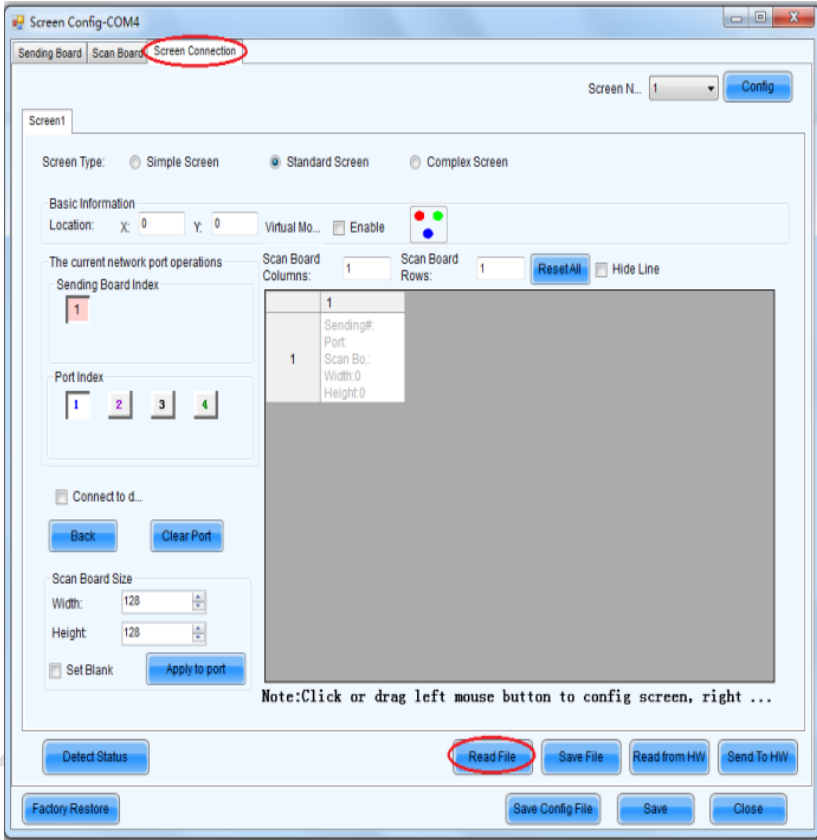

Fig 3-9 Screen Connection

- 2) Click **Send to HW**.

3) After sending, confirm that the screen is complete. Then click **Save**.

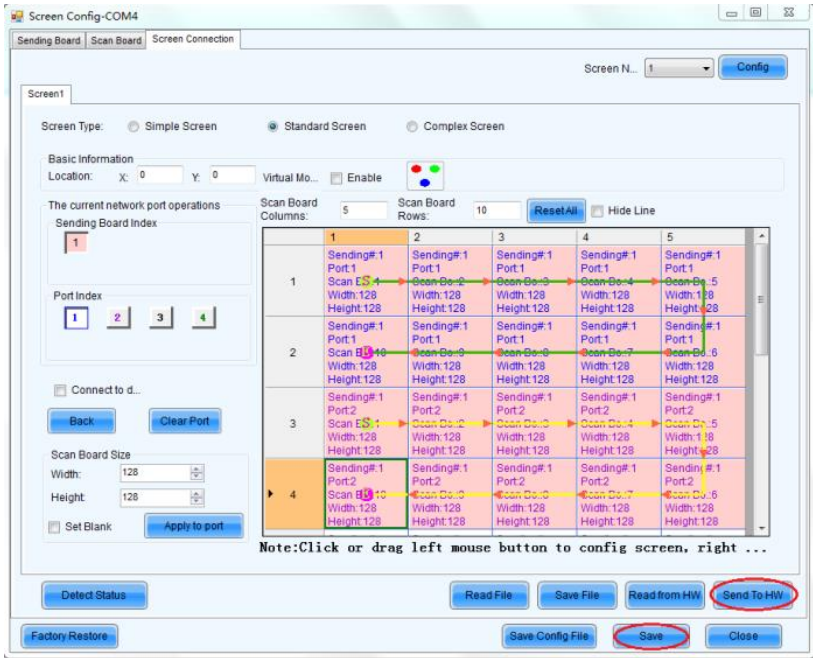

Fig 3-10 Screen Connection with Loaded File

3.3.3 Brightness Adjustment

On the main window, click **Brightness**, as shown in Figure 3-11, to display the brightness adjustment interface:

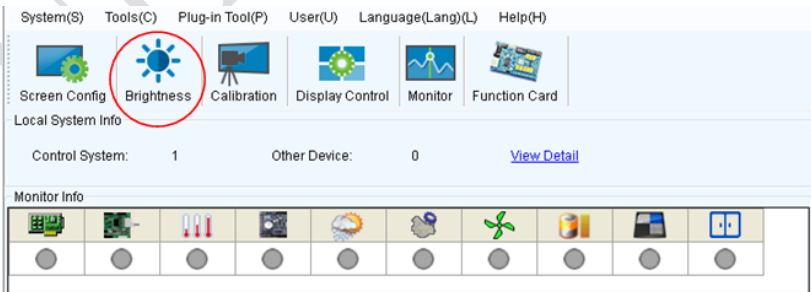

Fig 3-11 Main Window for Advanced User

There are four brightness adjustment modes, namely **Manual**, **Schedule**, **Auto**, and **Auto Adjustment by Hardware**. After adjustment is finished, click **Save to HW** to save the adjustment results to the hardware.

1. Manual Adjustment

Select **Manual** and adjust the brightness by dragging the scroll bar below **Brightness Adjustment** or directly modifying the brightness value (the maximum value is 255) next to the scroll bar.

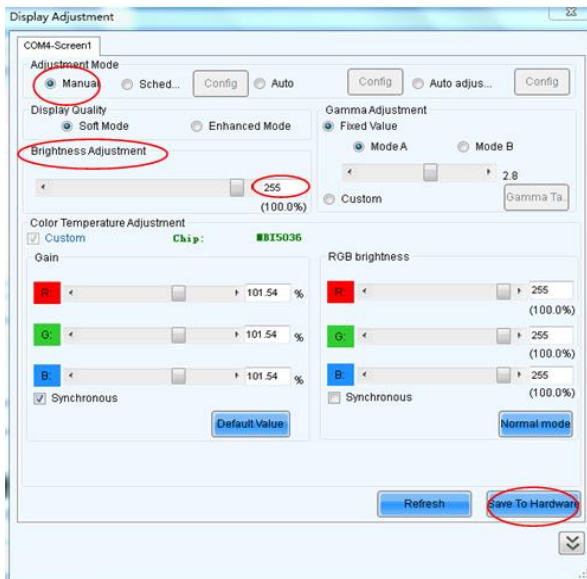

Fig 3-12 Manual Adjustment

Display Quality: Includes Soft mode and Enhanced mode. The Soft mode is generally used for indoor LED displays while the Enhanced mode is used for outdoor LED displays.

Gamma Adjustment: Includes Mode A and Mode B. The LED display in Mode A can light up earlier than that in Mode B.

Gain: For chips with current gain function, adjusting the current gain can improve the chip's current output.

RGB brightness: Adjusts the brightness of Red (R), Green (G) or Blue (B) separately.

2. Automatic Adjustment

Schedule, **Auto**, and **Auto Adjustment by Hardware** are automatic adjustment modes. Automatic adjustment function is not recommended for indoor LED display products because the indoor environment has stable ambient light and is rarely affected by the ambient brightness. If you really need to use this function, you can configure this function by using the wizard.

3.3.4 Correction Coefficient Management

The UTWII series products have been subject to correction before shipment. To ensure the optimum displaying effect of the screen, you need to activate the correction function when using the LED display, and to reload the correction coefficients after replacing the modules or receiving card. This Section introduces how to upload the correction coefficients after replacing the modules or receiving card.

On the main window, click **Calibration**, as shown in Figure 3-13, to display the screen calibration interface:

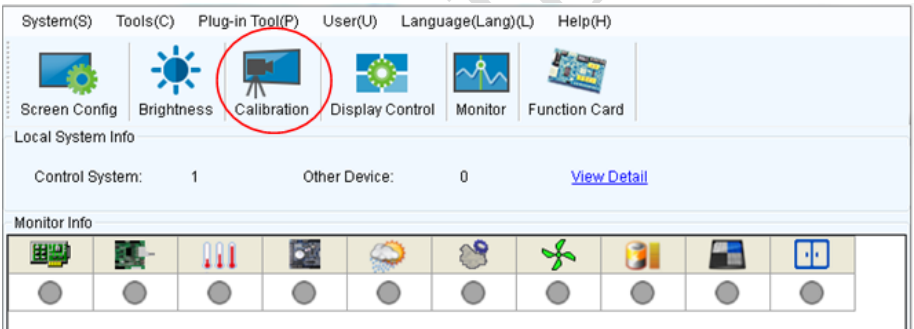

Fig 3-13 Main Window for Advanced User

Configure **Enable/Disable Calibration to Brightness**, click **Save**, and then click **Manage Coefficients** to display the following window:

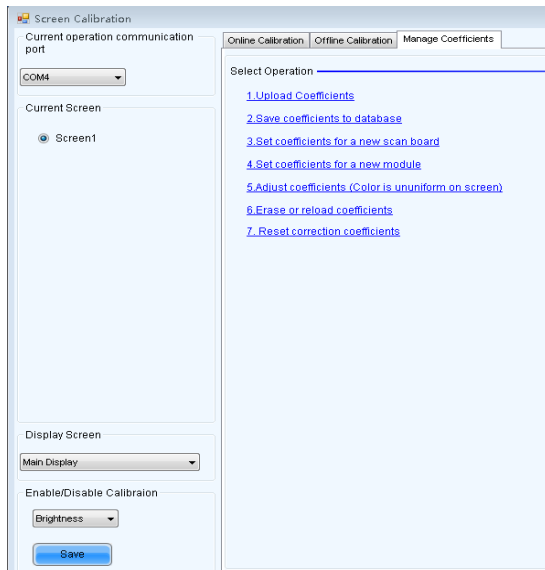

Fig 3-14 Manage Coefficients

Upload coefficients: Upload the correction coefficient database generated by the software or read back by the display screen to the screen.

Save coefficients to database: Read back and save the coefficients from the screen to the coefficient database.

Set coefficients for a new scan board: After replacing the scan board (receiving card), set the correction coefficients for the new receiving card.

Set coefficients for a new module: After replacing a module, set the correction coefficients for the new module.

Adjust Coefficients (Color is uniform on screen): Adjust the correction coefficients for a selected area on the screen to achieve a satisfactory effect.

Erase or reload Coefficients: Erase or reload the correction coefficients for a selected area on the LED display.

Reset Correction Coefficients: Reset the calibration coefficients on whole or selected section of LED display.

3.3.4.1 Setting Coefficients for a New Receiving Card

- 1) As shown in Figure 3-15, select **Topology or List**. Select the position of the replaced receiving card. Click **Next**:

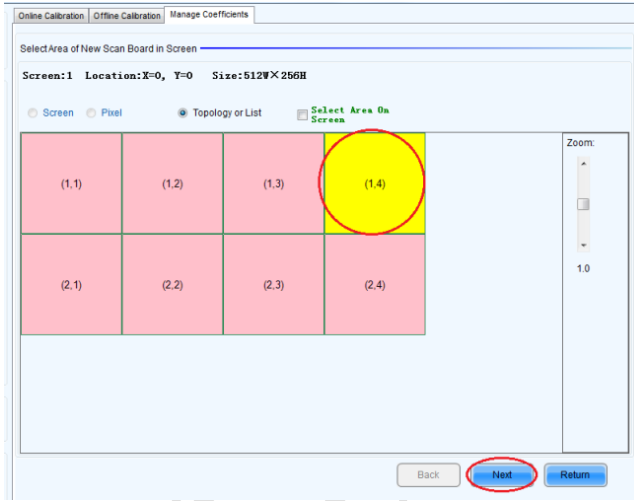

Fig 3-15 Selecting Area for New Receiving Card

- 2) Select the coefficient source. Click **Browse** at **Select Database**.

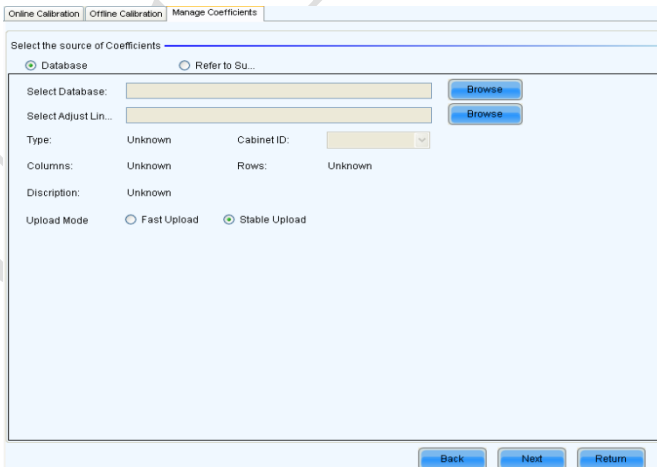

Fig 3-16 Obtaining Correction Coefficients for Receiving Card

3) Select the corresponding correction coefficients:

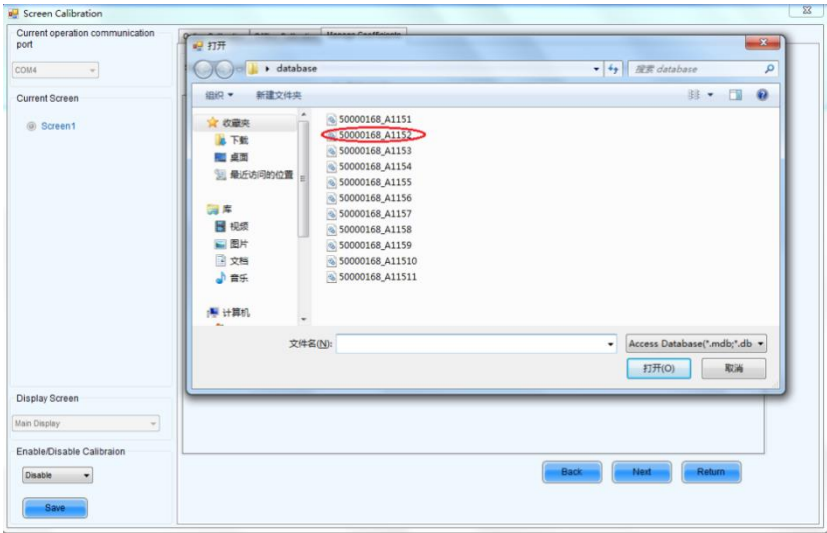

Fig 3-17 Selecting Correction Coefficients for Receiving Card

4) Select **Stable Upload** and click **Next**:

Fig 3-18 Uploading Correction Coefficients

5) Adjust Coefficient: Perform a simple adjustment if the displaying effect is not good enough after you upload the coefficient. Then click **Next**.

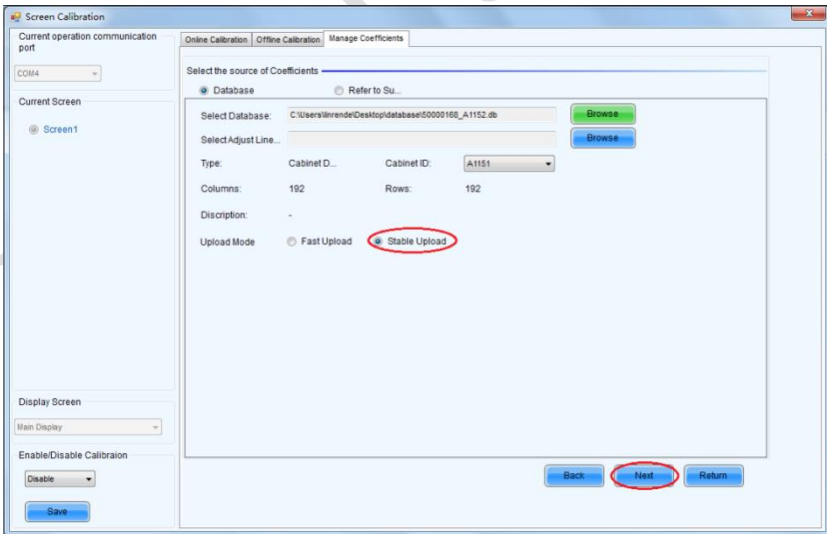
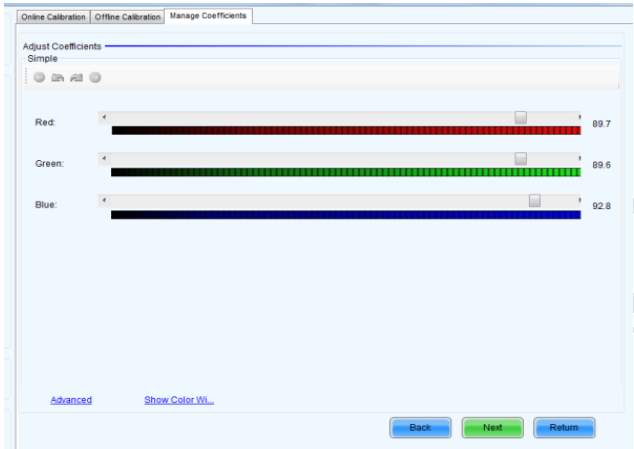

Fig 3-19 Simple Adjustment

Red: Adjust the red brightness value of calibration coefficients.

Green: Adjust the green brightness value of calibration coefficients.

Blue: Adjust the blue brightness value of calibration coefficients.

6) Save Coefficients: Click **Save** to save the correction coefficients to the hardware. The saved coefficients are retentive even after a power failure. Then click **Finish**.

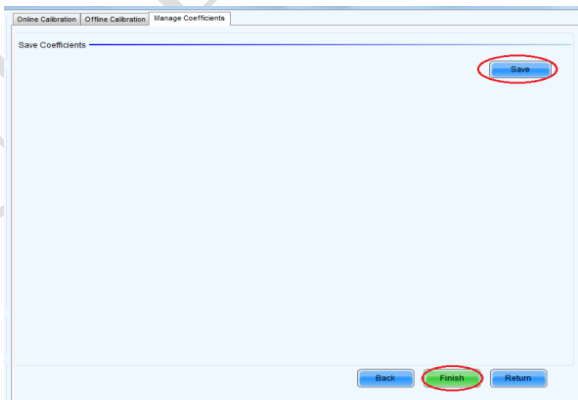

Fig 3-20 Saving Correction Coefficients

3.3.4.2 Setting Coefficients for a New Module

1) Select Position of the New Module: Select **Topology or List**. Then select the position of the receiving card where the new module is located. Double click the selected position:

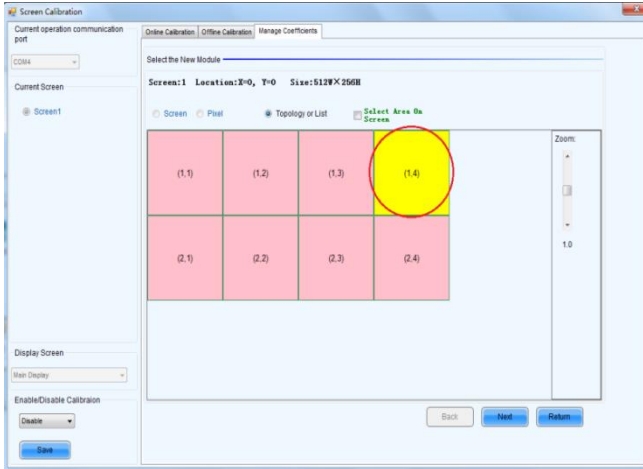

Fig 3-21 Selecting Cabinet for the New Module

2) Choose **Display Mode** to **Modules**. Select the position of the new module and click **Next**.

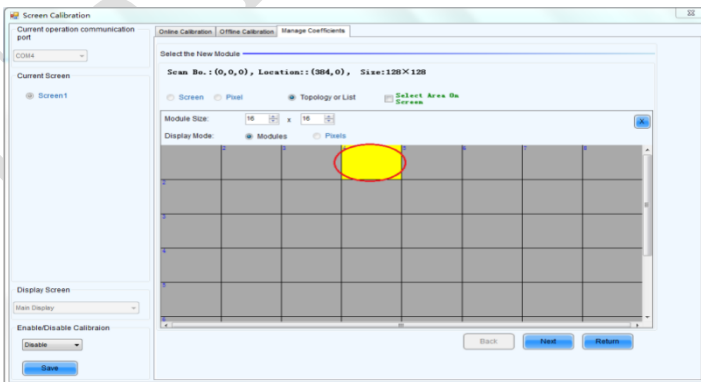

Fig 3-22 Selecting Position of New Module

Module Size: Set the size of the module in a cabinet. The software determines each module arrangement based on module size and cabinet size.

- 3) Adjust the coefficients (similar to the steps of coefficient adjustment in setting coefficients for a new scan board). For details, refer to Step 2 and Step 3 in Section 3.5.1).
- 4) Save the correction coefficients to the hardware (Use similar steps in setting coefficients for a new receiving card. For details, refer to Step 4, Step 5, and Step 6 in Section 3.5.1) so that they are retentive after a power failure.

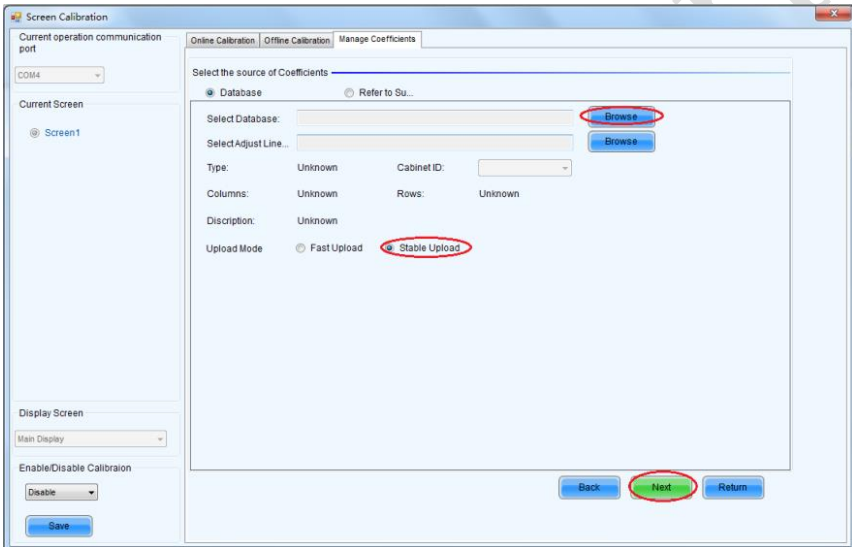
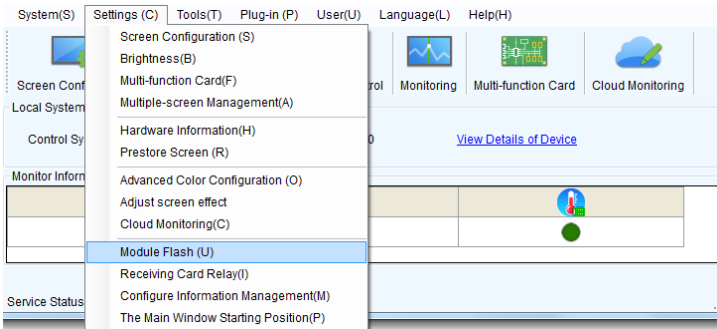

Fig 3-23 Obtaining Correction Coefficients for a New Module

3.3.4.3 Replace Module with Flash

The module of UTWII has Flash, which can save the calibration coefficient. After replacing the module, make sure that the receiving have read coefficient from the Flash and save.

Click **Setting** on the main window and select **Module Flash**, as shown in following fig.



Main Window

Click **Check Coefficient in Modules**, the receiving card will read coefficient from module, then **Click Save Calibration Coefficient on Receiving Card**

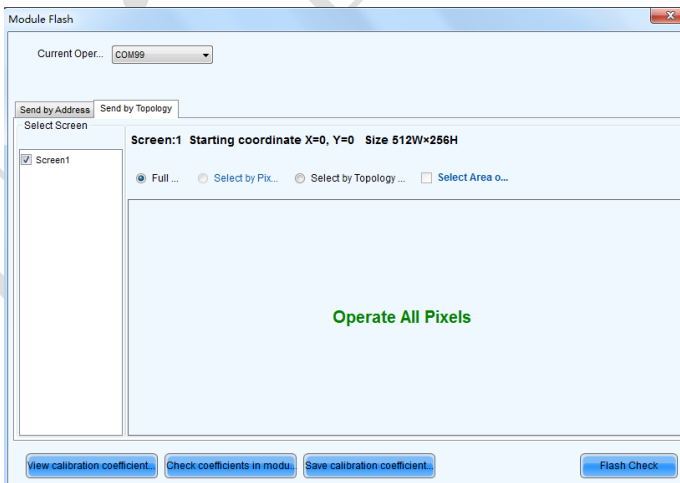
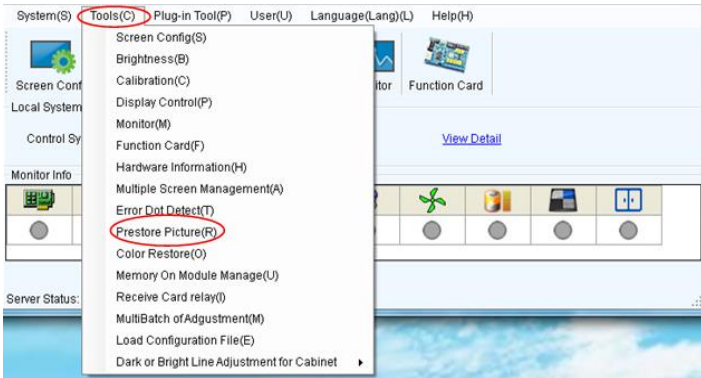

Fig 3-24 Save Calibration Coefficient on Receiving Card

3.3.5 Pre-storing Picture

On the Prestore Picture interface, you can save a picture as the prestored picture for the screen. This prestored picture can be set as a screen displayed upon booting, signal cable disconnection, or DVI signal absence.

On the main window, click **Tool** and select **Prestore Picture**, as shown in Figure 3-25.



Prestore Picture

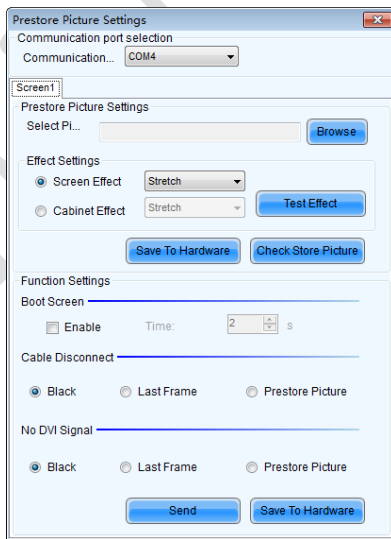

Fig 3-25 Prestore Picture Settings

1) Prestore Picture Settings

Select Picture: Click **Browse** to select the directory of the picture.

Screen Effect: Set the selected picture to be displayed on the whole screen by means of stretching, tiling, or centering.

Cabinet Effect: Set the selected picture to be displayed on each cabinet of the screen by means of stretching, tiling, or centering (the number of pictures displayed by each cabinet shall be equal to the number of receiving cards in the cabinet).

Click **Test Effect** to display the selected picture on the screen.

Click **Save to Hardware** to save the picture as a prestored picture to the hardware.

Click **Check Store Picture** to display the stored picture on the screen so as to check its effect.

2) Function Settings

Boot Screen: Set whether to use the prestored picture and set the displaying time of the prestored picture when the screen is powered on.

Cable Disconnect: Set the picture to be displayed by the cabinet whose signal cable is disconnected.

No DVI Signal: Set the picture to be displayed in the period in which the screen does not receive any DVI signals.

Click **Send** to the settings to the hardware (the settings will be lost if you do not click **Save to Hardware**).

Click **Save to Hardware** to save the current settings so that these settings are retained even if there is a power failure.

3.4 Unilumin K series - Software Control Setting

3.4.1 Installing the Software

Open the optical disk provided for the delivered products. Install the LED control software Unilumin.exe stored in the optical disk to the control PC.



Fig 3-26 Software Installation

NOTE: You can follow the software installation wizard to install the software.

3.4.2 Display Configuration

3.4.2.1 Login to the Display Settings Interface

1) Open the software, enter the main window, click “Control” → “LED Screen Settings”; enter the password: 168 in the pop-up password box ,then enter the LED Screen Settings interface, as shown below:

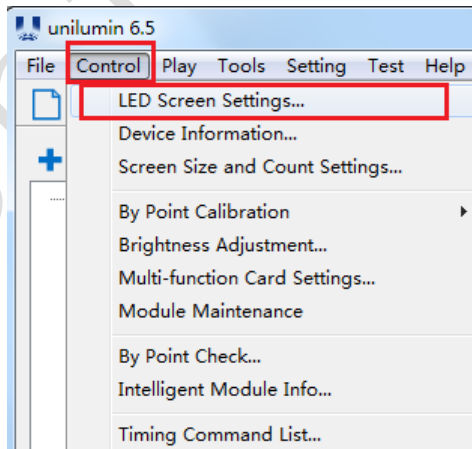

Fig 3-27 Main Window

Chapter 3 LED Display Control Setting

Device” page will display the information of the sending card in detail: the card type and quantity, the input signal information of the sending card, etc, as shown below:

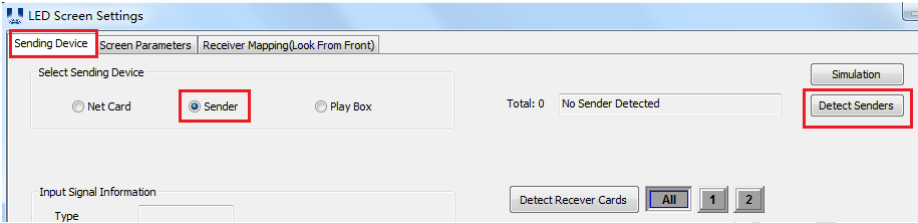

Fig 3-30 Detect Senders

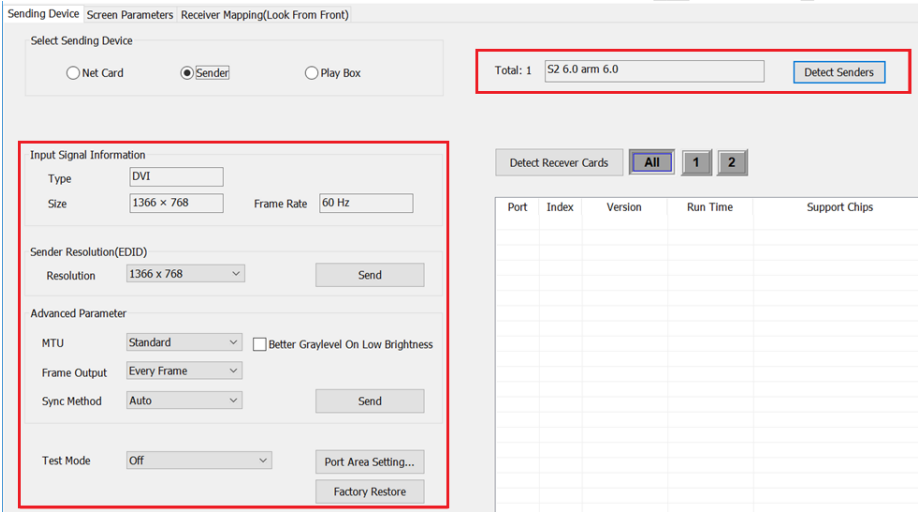

Fig 3-31 Sending Card Information

2) Input Signal View

After detecting the sending card , if the video signal is connected properly. The video input signal type, frame rate, width and height are displayed in detail in the “Input Signal Information”.

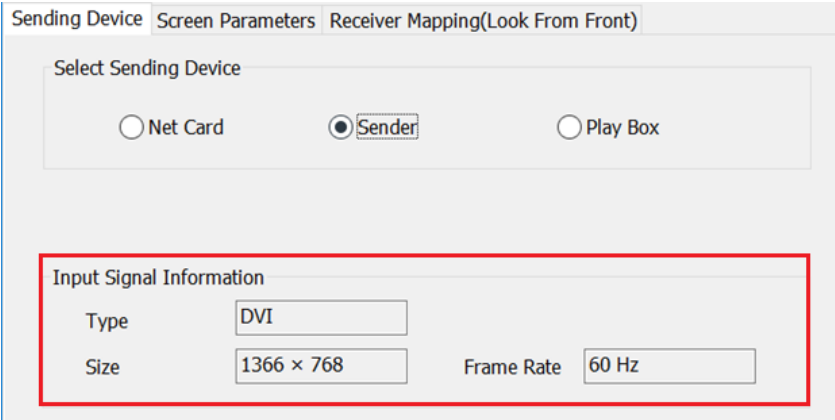

Fig 3-32 Input Signal Information

3) Settings the Sending Card Parameters

After detecting the sending card, can make some settings on the sending card parameters on the “Sending Device” page.

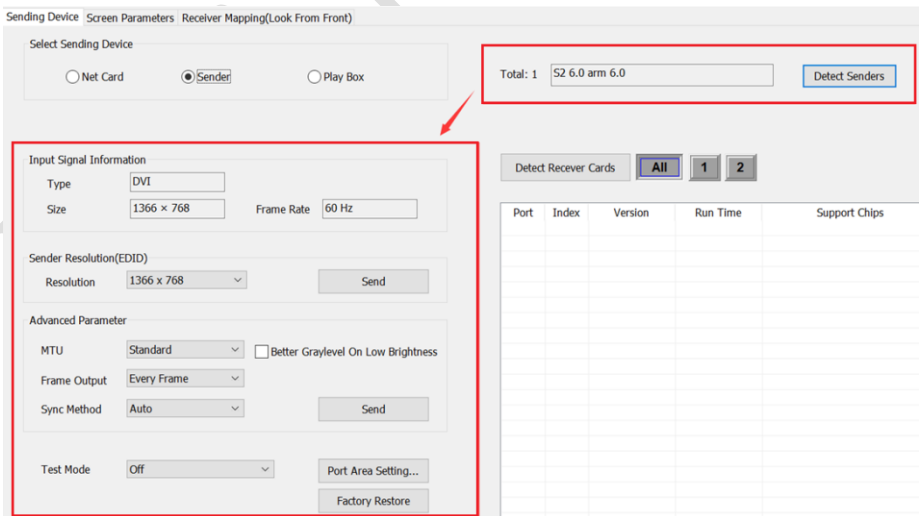

Fig 3-33 Settings the Sending Card Parameters

3.4.2.3 Screen Parameters Setting

After setting the send card interface, click “Screen Parameters” to set the screen parameters:

- 1) Click "Load..." to load the "xxxx. rcvbp " file on the CD
- 2) Click "Send"

3) After sending is complete, confirm that the display screen menu of the single receiving card is normal, click “Save to Receivers” to save

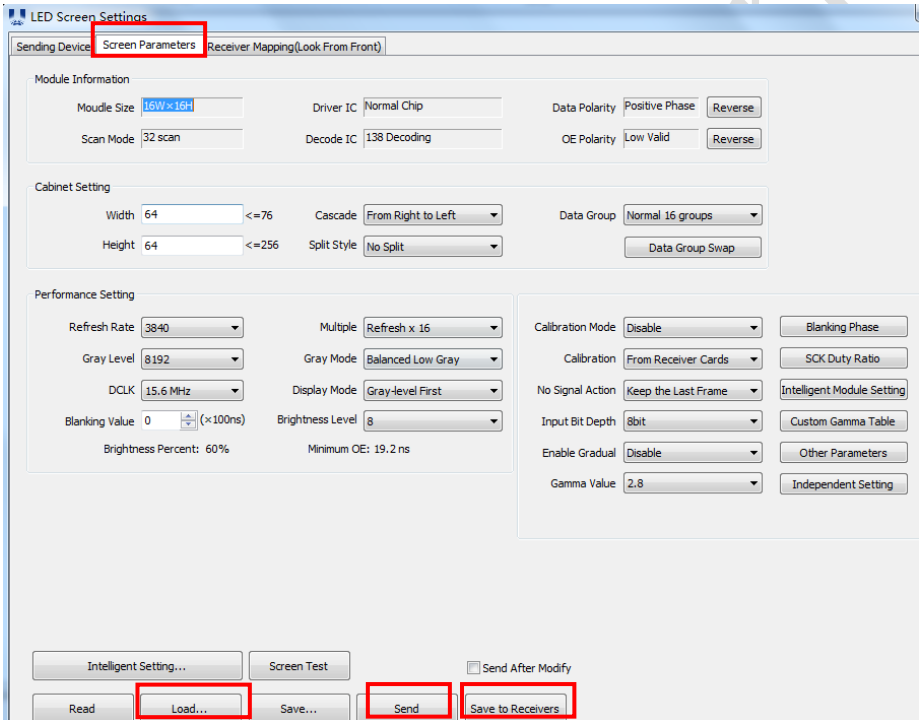

Fig 3-34 Screen Parameters

3.4.2.4 Display Connection

After the screen parameters are solidified to the receiving card, click on “Receiver Mapping” to setting, connect the display.

- 1) Click "Load..." , load the "xxxx. mapping " files on the disc;
- 2) Click "Send";
- 3) After sending is complete, confirming that the display screen menu is normal, click “Save to Devices” to save.

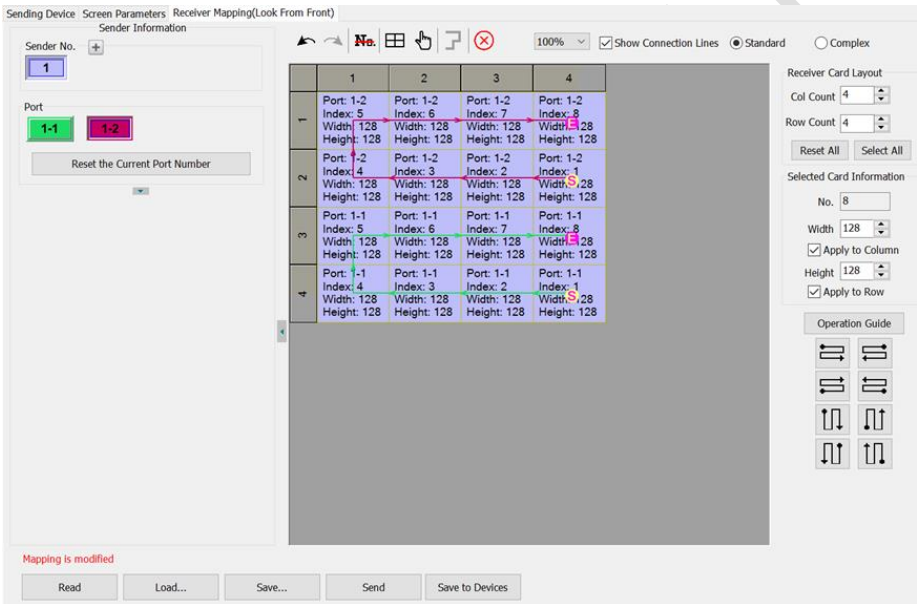

Fig 3-35 Receiver Mapping

3.4.3 Brightness Adjustment

In the main window, click “Control” → “Brightness Adjustment” , enter the brightness adjustment interface and adjust the brightness.

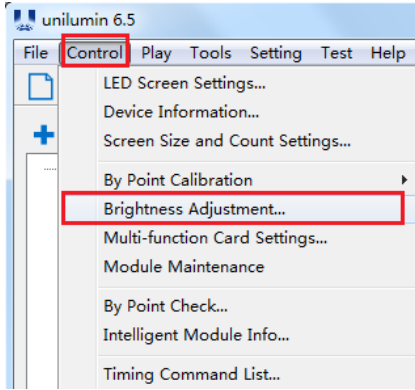

Fig 3-36 Brightness Adjustment

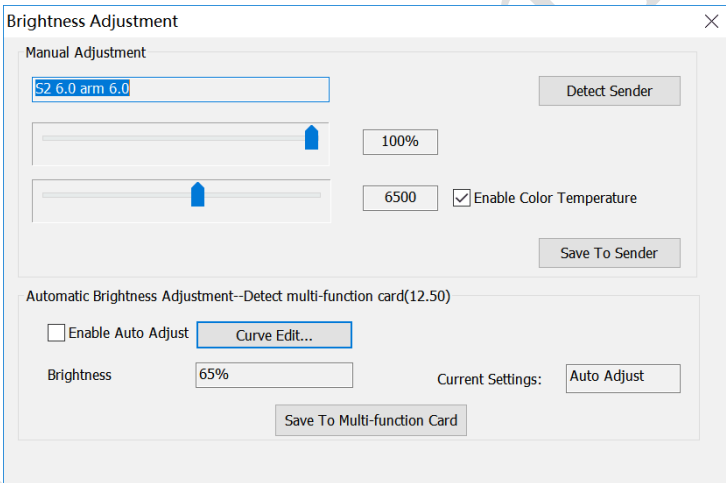

Fig 3-37 Brightness Adjustment Interface

There are various ways to adjust the brightness: automatic adjustment of multi-function card, timing brightness adjustment, manual adjustment, white balance adjustment, brightness correction adjustment, etc.

- 1) Manual adjustment: In the brightness adjustment interface, manually pull the brightness bar to change the brightness percentage , adjust the brightness of the display.

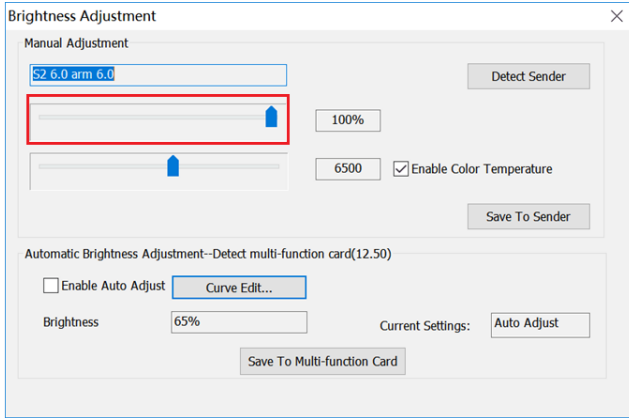

Fig 3-38 Manual Brightness Adjustment

- 2) Automatic brightness adjustment: In the brightness adjustment interface, check “Enable auto adjust” and click “Save to Multi-function Card”. The brightness is the current brightness percentage of the display.

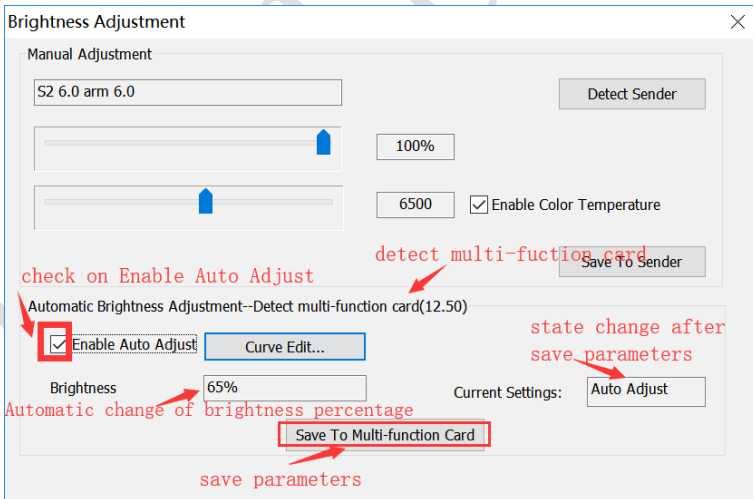

Fig 3-39 Automatic Brightness Adjustment

3.4.4 Calibration

3.4.4.1 Setting Coefficients for a New Module

- 1) First set the window to be greater than or equal to the actual screen pixel size;

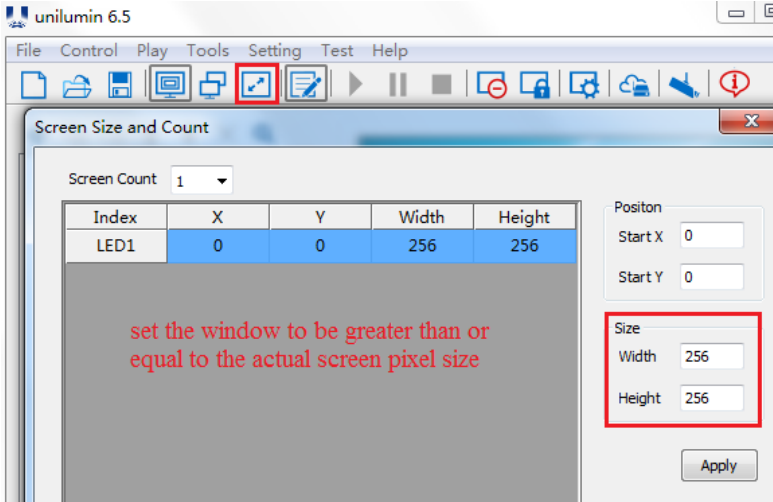

Fig 3-40 Screen Size and Count

- 2) In the main window, click “Control” → “By Point Calibration” → “Brightness Calibration”, enter the calibration interface;

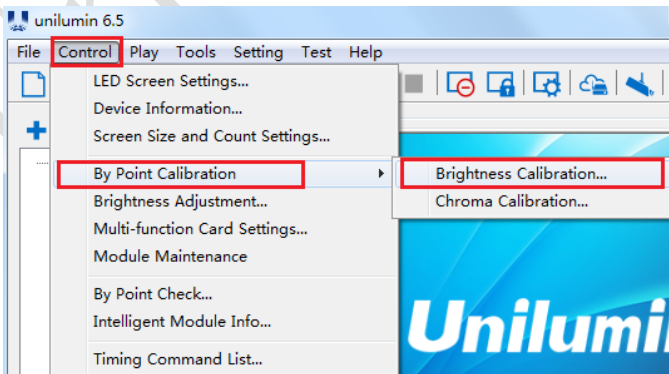

Fig 3-41 Main Window

- 3) Click “Get Screen Information” → “Read” ,get screen information and read back the screen correction coefficient;

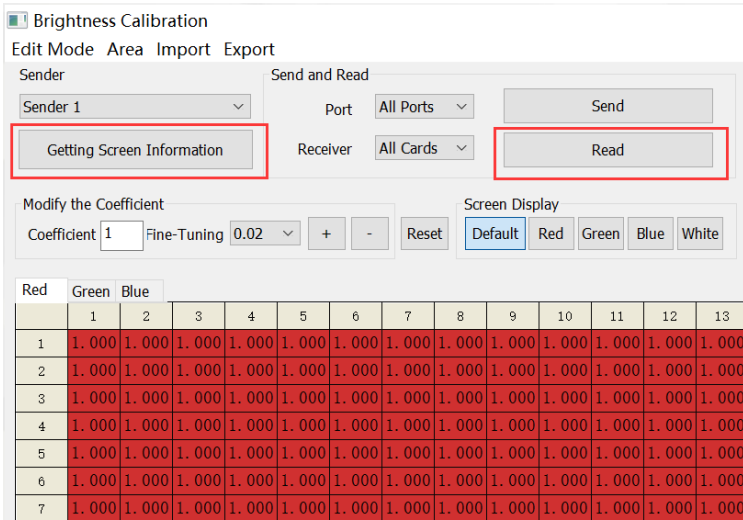

Fig 3-42 Brightness Calibration

- 4) Click “Import” → “By Region” → “Normal” to import the correction coefficient of the replaced spare module;

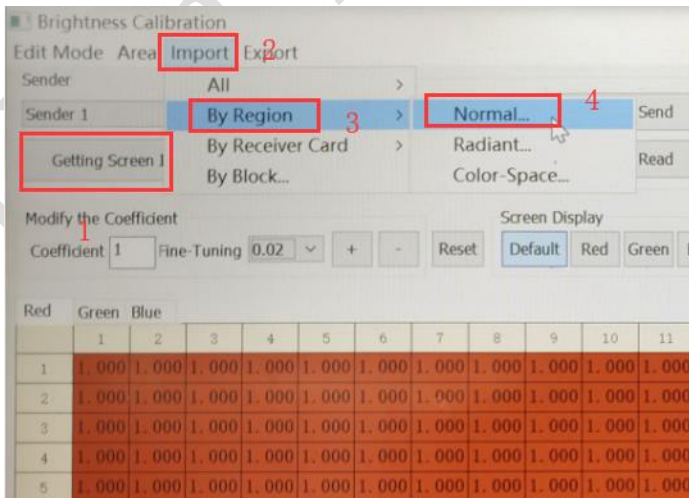

Fig 3-43 Brightness Calibration

- 7) After importing the calibration file, click "Send" to enable brightness correction;

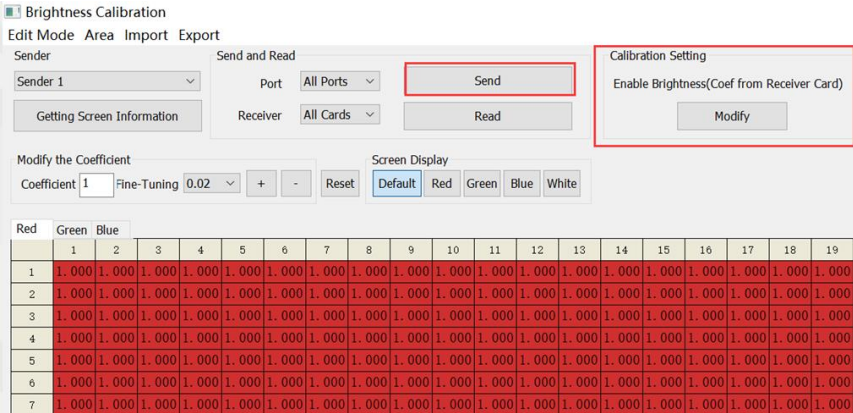

Fig 3-46 Brightness Calibration

- 8) Open the LED screen setting window, on the screen parameter page :select “Brightness” in the “Calibration Mode”, select “From Receiver Card” in the “Correction”, and then click “Save to Receivers”.

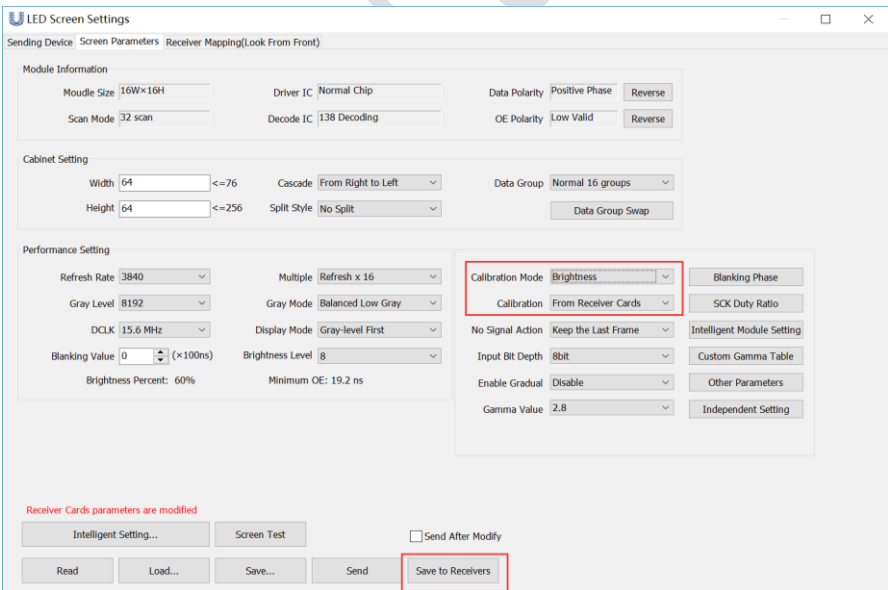

Fig 3-47 LED Screen Setting

Chapter 4 LED Display Playing Setting

4.1 Unilumin N series - LED Display Playing Setting

4.1.1 Selecting a Playing Solution

The playing software UniStudio has three playing modes, namely Simple playing program, Professional playing program, and Priority programs of the page. Professional playing program is used most commonly. This Section introduces the Professional playing program only.

Run the software to enter the main window. Click **Setting > Switch schedule mode**. On the editing mode setting window, select **Professional playing program** and click **OK**. As showed in Fig 4-1 and Fig 4-2.

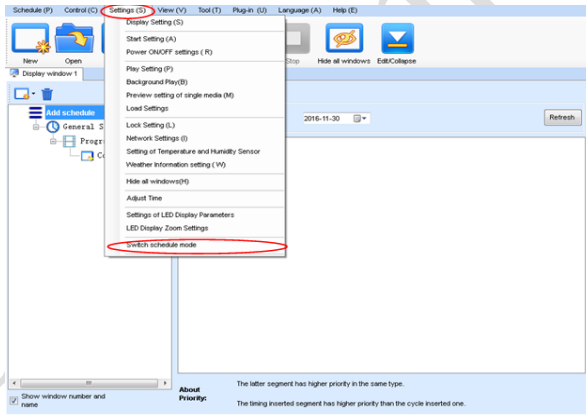

Fig 4-1 Switching Schedule Mode

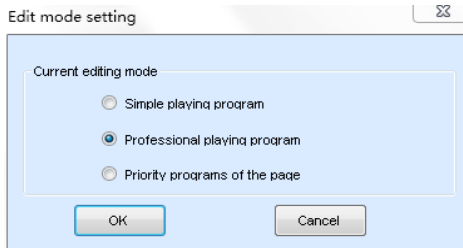

Fig 4-2 Edit Mode Setting

4.1.2 Playing Setting

4.1.2.1 Display Window Setting

Run the UniStudio, click **Settings** and select **Display Setting**, as in following fig:

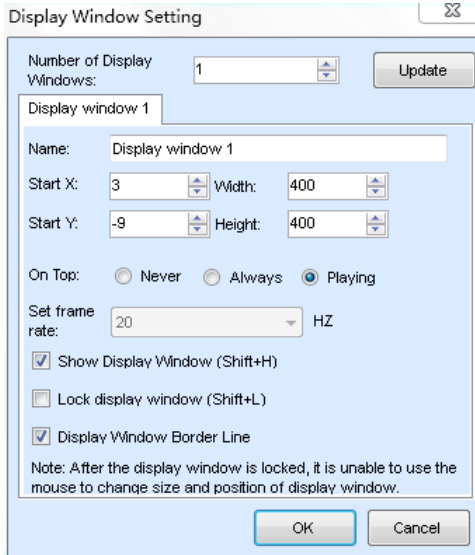

Fig 4-3 Display Window Setting

Number of Display Windows: Indicates the number of display windows. To increase or decrease the number of display windows, re-enter the number of display windows in the box next to **Number of Display Windows** and then click **Update**.

Start X: Indicates the horizontal start point of the display window.

Start Y: Indicates the vertical start point of the display window.

Width: Indicates the horizontal pixel value of the display.

Height: Indicates the vertical pixel value of the display.

Other configuration items are set to the default values.

4.1.2.2 Startup Setting

On the main window of the software, click **Setting > Start Setting** to enable the software to run automatically upon startup of the PC and to automatically activate a playing solution. See Fig 4-4:

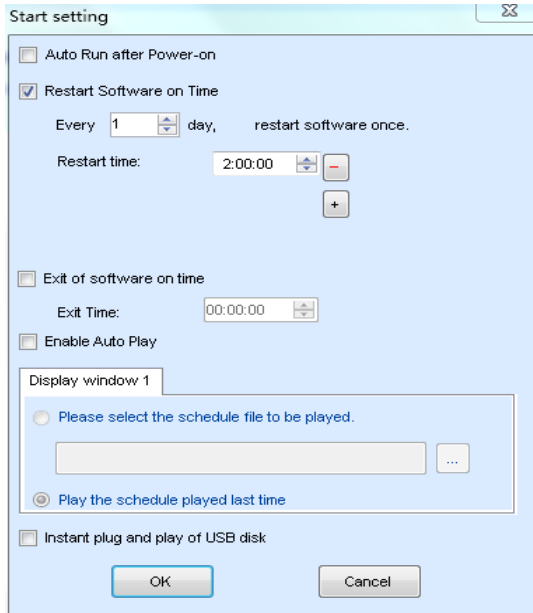

Fig 4-4 Startup Setting

Auto Run after Power-on: If you enable this function, UniStudio will run automatically the next time when the PC is started.

Restart Software on Time: If you enable this function, set the restart interval and time, and click **OK**, UniStudio will be automatically restarted after the PC time reaches the preset restart time. After the software is restarted, the window information and playing status before restart will be automatically recovered.

Exit of software on time: If you enable this function and set the exit time, the software will exit automatically upon the preset time. This function can prevent damages to the uploaded data caused by forcible exit of the software.

Enable Auto Play: If you enable this function and specify a playing solution for the screen, the software will automatically activate the specified playing solution once the software is started.

Instant plug and play of USB disk: If you enable this function, the PC will automatically read and activate the playing solution once the USB flash drive is inserted to the PC. If you do disable this function, the PC cannot implement the plug-and-play function even though you have inserted the USB flash drive to the PC.

4.1.3 Editing Professional Playing Solution

4.1.3.1 Editing the Time Segment

1) Creating a playing solution

On the main window of the software, click **Schedule > New**, as shown in Fig 4-5:

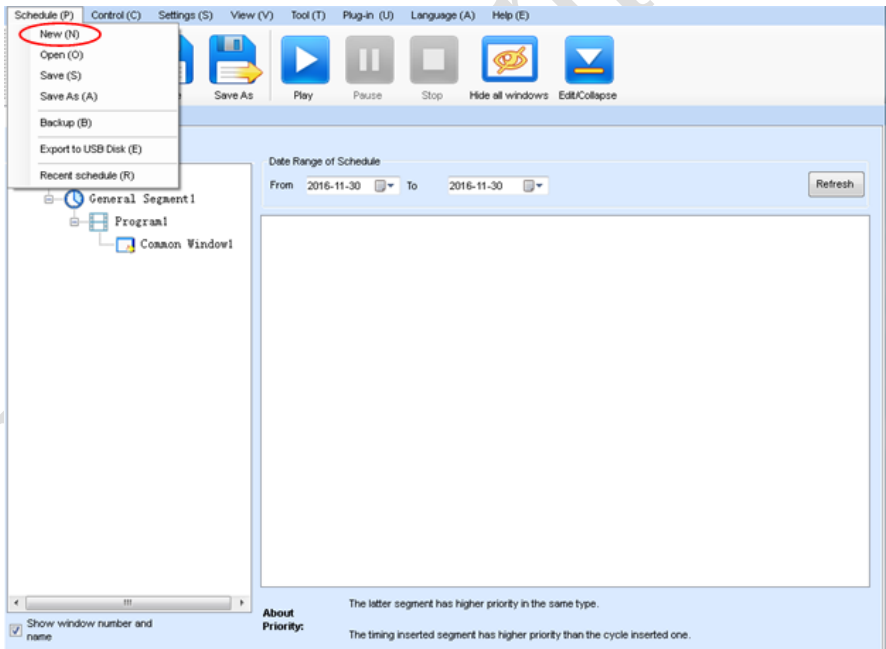

Fig 4-5 Creating a Playing Solution

2) Editing the properties of the playing solution

After adding a general time segment or interstitial segment, click **General Segment 1** to edit the properties displayed in the segment editing area on the right side, as shown in Fig 4-6:

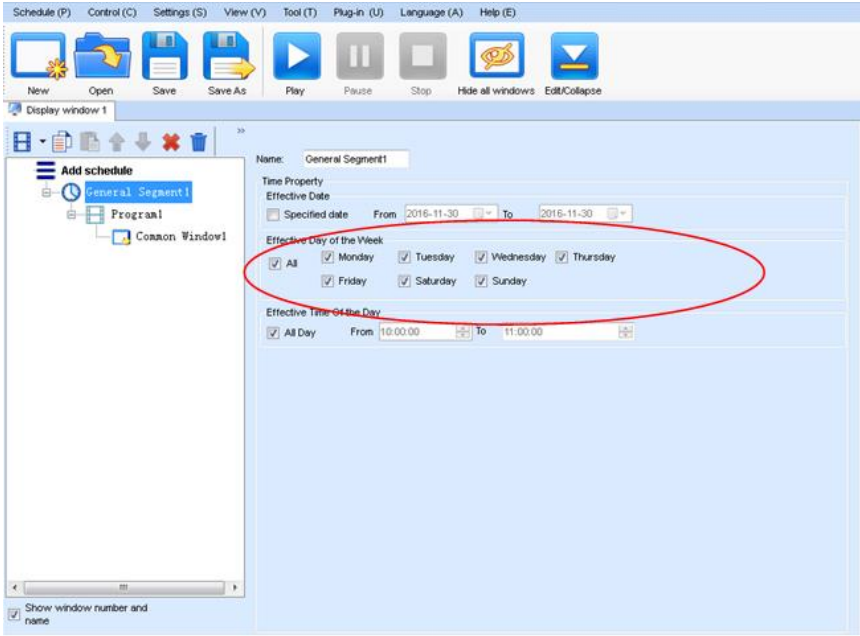

Fig 4-6 Properties of General Time Segment

4.1.3.2 Editing the Program Page

1) Creating a program page

As shown in Fig 4-7, right click **General Segment** or click the **Add Global Program Page** in the toolbar to create a program page:

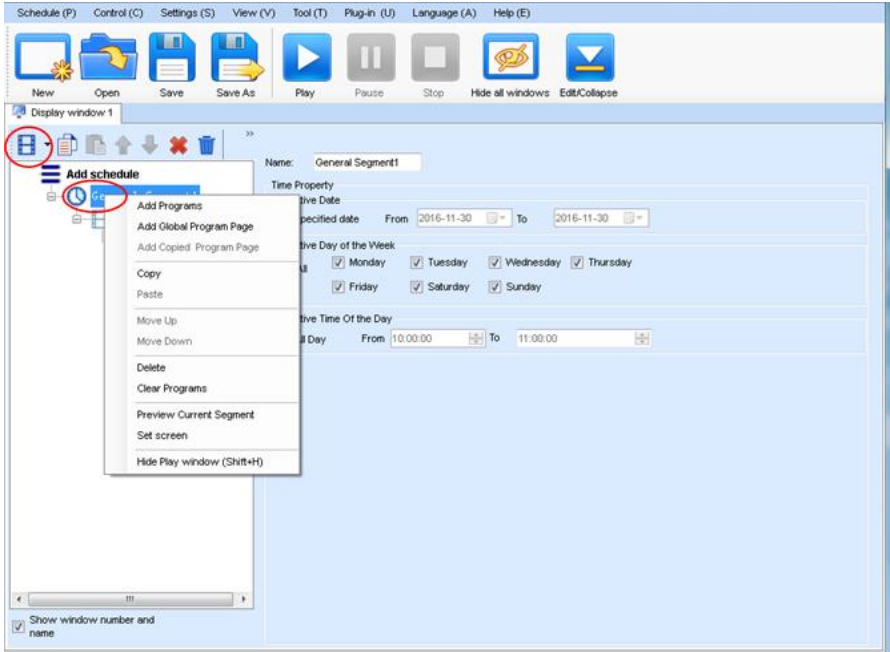

Fig 4-7 Creating a Program Page

2) Setting the properties

After creating the program page, click **Program 1** and set the background, displaying mode, and other properties displayed on the property page on the right side. See Fig 4-8:

Chapter 4 LED Display Playing Setting

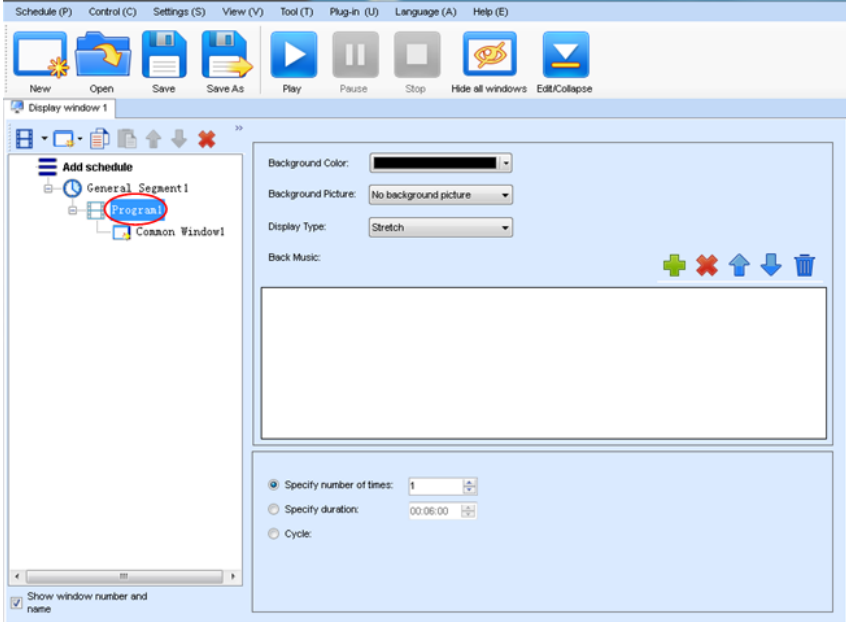

Fig 4-8 Properties of Program Page

If you select **Specify Number of Times**, the next general program page is played after the preset **Times to Play** for the display window with the longest playing time on the current program page has been reached.

If you select **Specify Duration**, the next program page is played after the preset **Play Duration** for the current program page has been reached.

If you select **Cycle**, the current program page will be played cyclically all the time.

When the current program page is played, the background picture or colour of the program page is displayed in the area not covered by the display window, as shown in Figure 4-9:



Fig 4-9 Background of Program Page

After adding the program page, you can move, copy, paste, or delete the program page by using the toolbar in the program page editing area, or by using the short-cut menu, as shown in Fig 4-10.

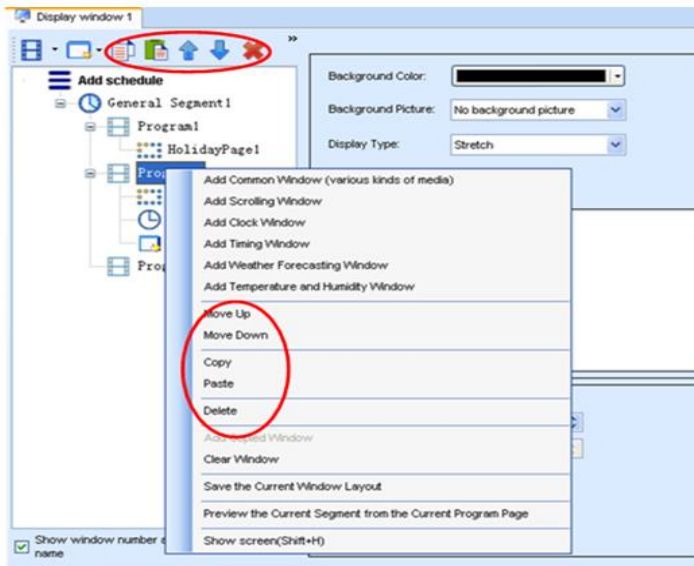

Fig 4-10 Program Page Operation Menu

4.1.3.3 Editing the Display Window

1) Adding a display window

After adding a program page, you need to add a display window to this program page. Click **Add Window** on the toolbar of the program page to add a window to the current program page. See Fig 4-11:

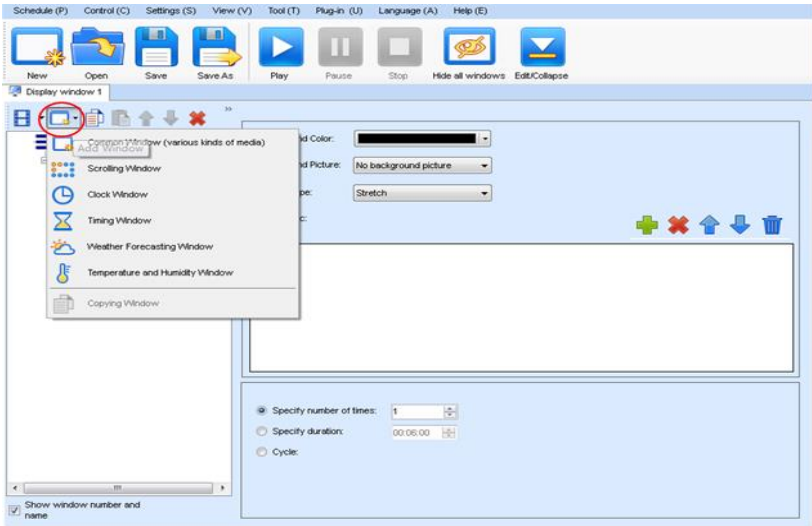

Fig 4-11 Adding a Window to Program Page

After the window is added, the added window is selected and displayed on the screen, as shown in Fig 4-12:

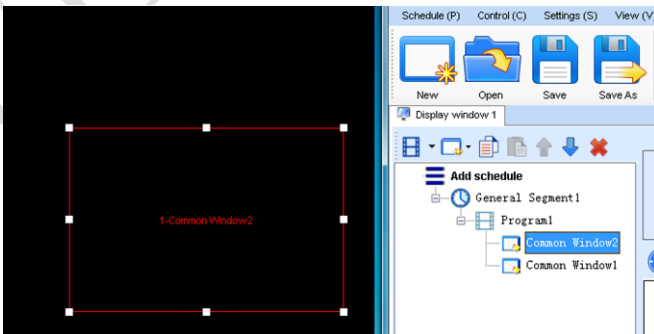

Fig 4-12 Added Window

2) Setting the location and size of the display window

The location and size of the new window is generated randomly and can be adjusted based on actual conditions by using either of the following two methods:

- a) Directly specify the new location and size in the setting pane, as shown in Fig 4-13:

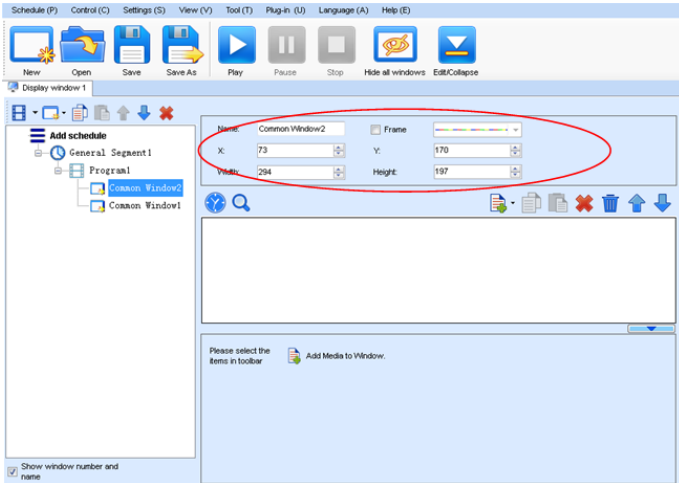

Fig 4-13 Setting the Window Size

- b) Click the display window on the screen and adjust its size by using the mouse, as shown in Fig 4-14:

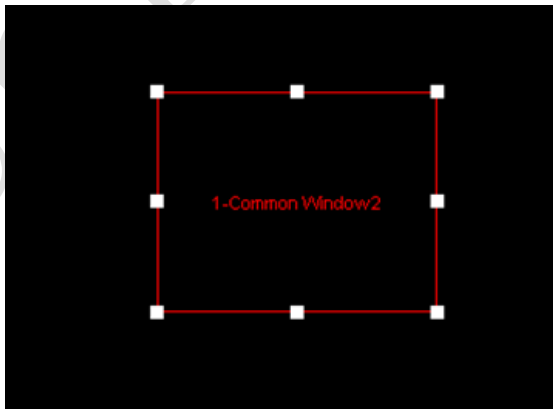

Fig 4-14 Adjusting the Window Size Using the Mouse

3) Deleting a display window

Select the window to be deleted. Click the delete key to delete the window, as shown in Fig 4-15:



Fig 4-15 Deleting the Display Window

4) Moving a display window

Select the program or window. Click the direction key to adjust the playing sequence, as shown in Fig 4-16:



Fig 4-16 Moving a Display Window

4.1.3.4 Editing the Media

1) Adding the media

The type of window for adding the media is **Common Window**. Click the **Add Media** button of a common window to select media of different types to be added into the media list. See Fig 4-17:

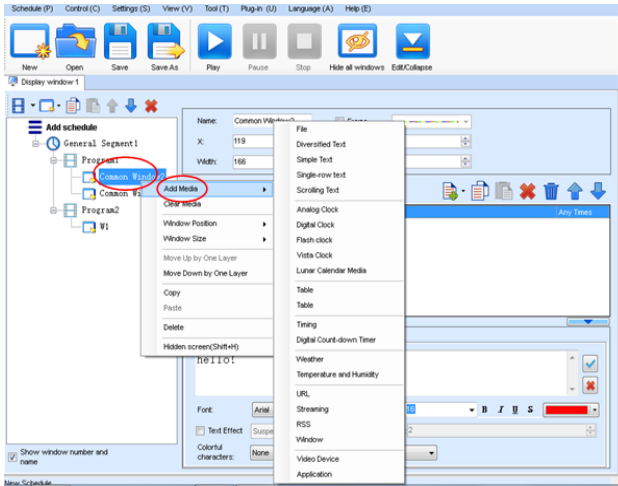

Fig 4-17 Adding the Media

After adding the media, you can set the media texts and properties, as shown in Figure 4-18.

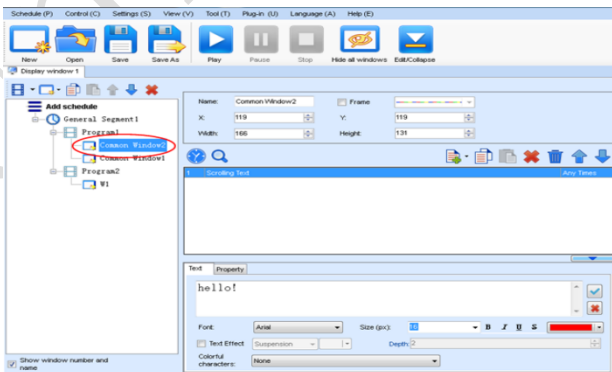

Fig 4-18 Media Setting Window

2) Setting the media properties

Different media have different properties. After a medium in the media list is selected, the property page of this medium is displayed below the selected medium. On this property page, you can change the properties of the medium. See Fig 4-19:

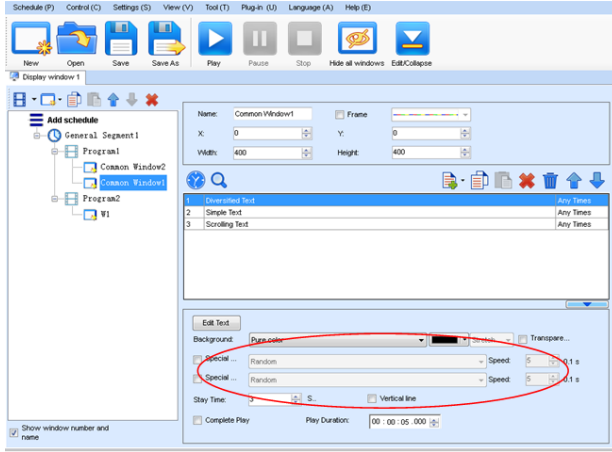
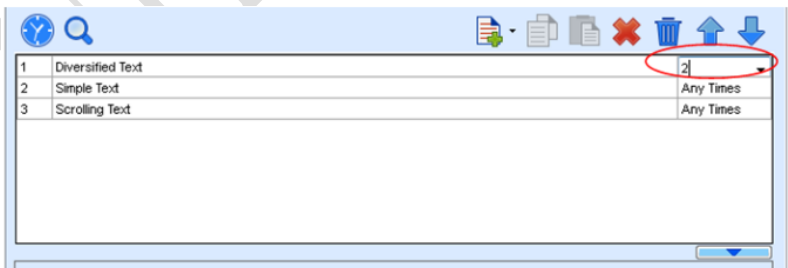

Fig 4-19 Properties of Medium

3) Editing the media in the common window

In an actual application, if different playing times are required for different media, you can select the media in the media list and then double click **Times to Play** to modify the playing times by either entering a new value or selecting a value from the drop-down list. See Fig 4-20:



Double click

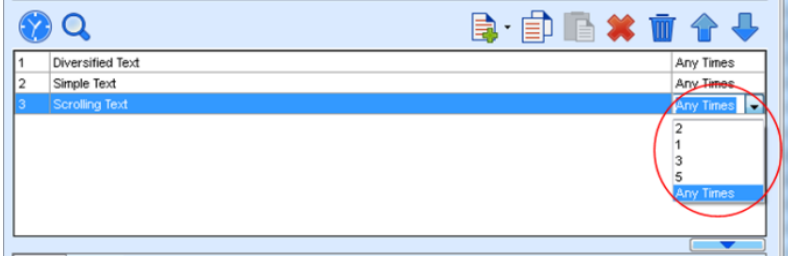

Modify

Fig 4-20 Changing the Media Playing Times

Right click the media to perform operations on the selected media, as shown in Fig 4-21:

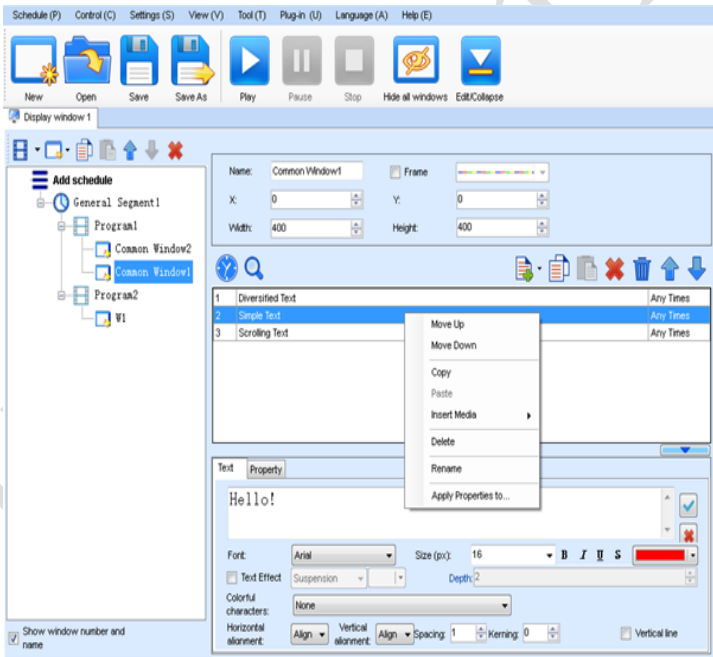

Fig 4-21 Media Operation Menu

Right click a blank area in the media playlist. A media playing menu is displayed, as shown in Fig 4-22:

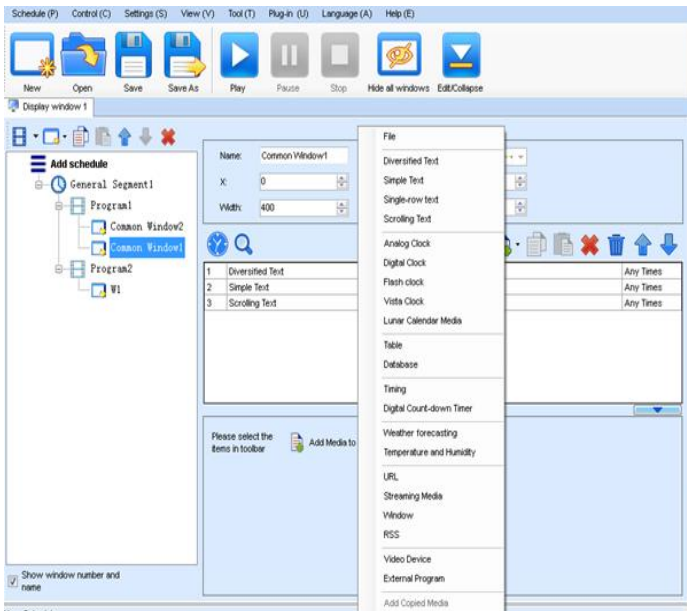

Fig 4-22 Media Playing Menu

4.1.3.5 Playing the Media

After the playing mode is edited or loaded, click the play key on the main toolbar to start the current playing mode, as shown in Fig 4-23:

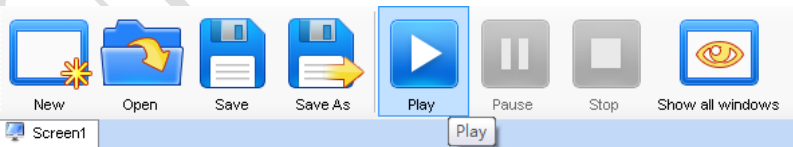

Fig 4-23 Play Key on the Toolbar

After play is activated, the editing page is switched to the playing page, as shown in Fig 4-24:

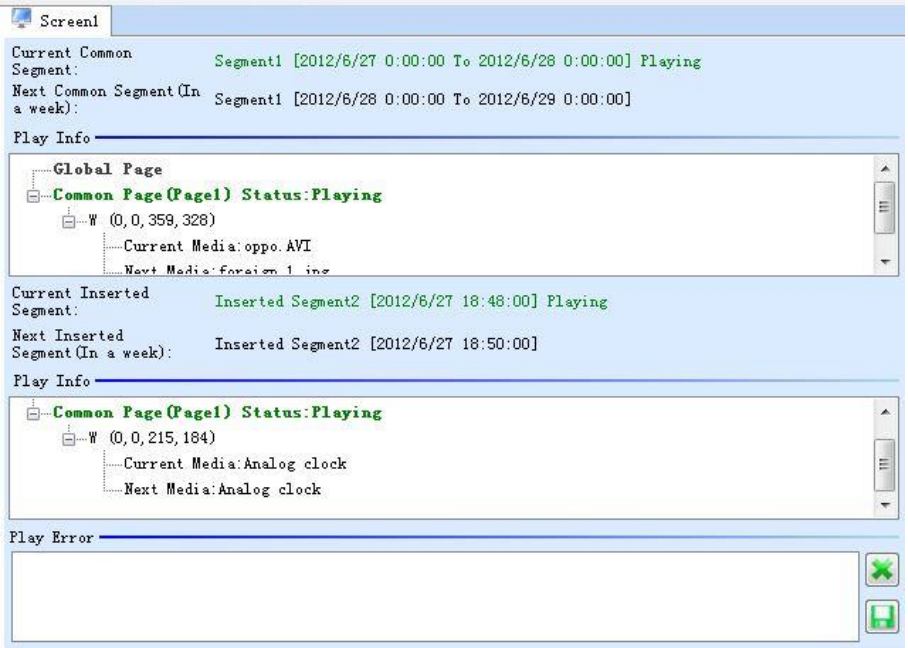

Fig 4-24 Play Information Page

Clicking **Pause** or **Stop** on the toolbar can pause or stop the currently played program. You can also perform this operation by using the operation menu that appears when you right click the display window. See Fig 4-25:

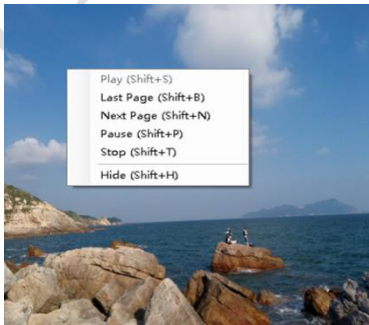

Fig 4-25 Short-cut Menu

Attention: All display windows on the same program page plays simultaneously. If the display windows overlap with each other, the upper-layer windows will cover the lower-layer windows. For example, if you add a common window and then a clock window of the same size and coordinate, the common window will cover the clock window when they are playing. If you want to display the clock window, you need to click **Pause**, perform the **Move Up** operation to move the clock window to the front side of the common window, and then click **Play**. If the clock is displayed transparently, the clock will overlay the media of the common window when the playing solution is played upon the moving operation. Figure 4-26 shows the displaying effect:

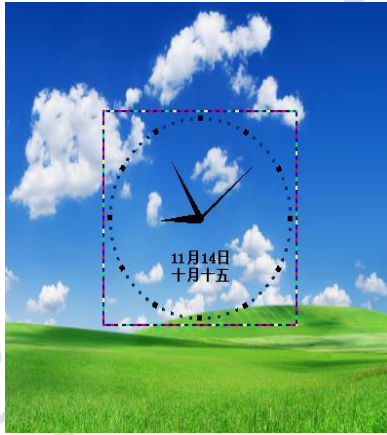

Fig 4-26 Transparent Displaying Effect of the Clock

4.1.4 Saving and Opening a Playing Solution

Save: After a playing solution is created, you can click **Schedule** on the toolbar and select **Save** or **Save As** to save the playing solution in the format of **xxxx.plym**. See Fig 4-27:

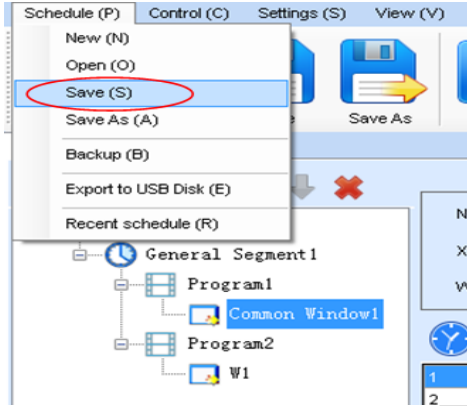

Fig 4-27 Saving a Playing Solution File

Open: After a playing solution is saved, you can directly click **Schedule** in the toolbar and select **Open** to open the playing solution. See Fig 4-28:

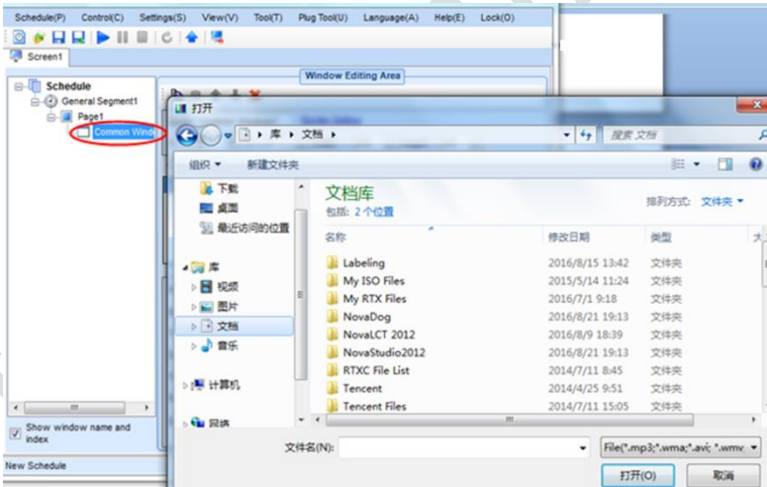

Fig 4-28 Opening a Playing Solution File

4.2 Unilumin K series - LED Display Playing Setting

4.2.1 Set the Count and Size of the Screen

Open the software, click "Control " → "Screen Size and Count Settings" in the main window, as shown below:

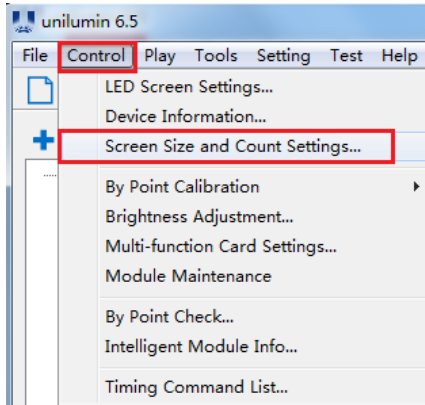

Fig 4-29 Main Window

Set the count of LED screens and the starting position and size of the screen in the " Screen Size and Count " window.

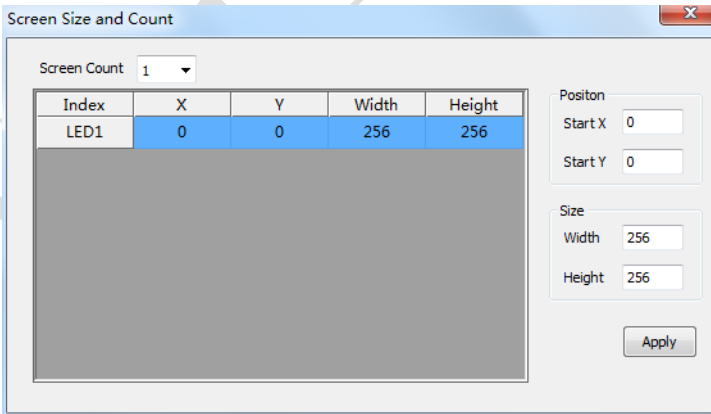

Fig 4-30 Screen Size and Count Settings

4.2.2 Setting the Program Page

The program page is divided into two types: "Normal Page" and "Global Page".

Global Page: The program page that is played continuously during playback, can contain multiple windows. Only one global page can be set per screen.

Normal Page: The normal page can contain multiple windows, and each normal page can have different window layouts.

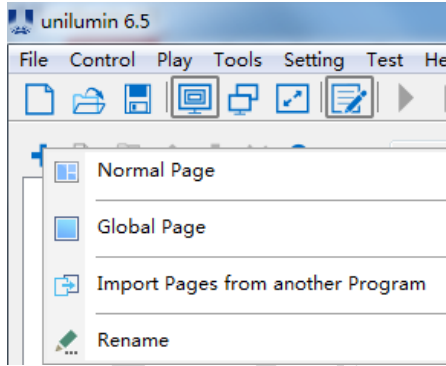

Fig 4-31 Program Page

- 1) Click the button  on the program editing toolbar, pop up the menu to create a new program page;

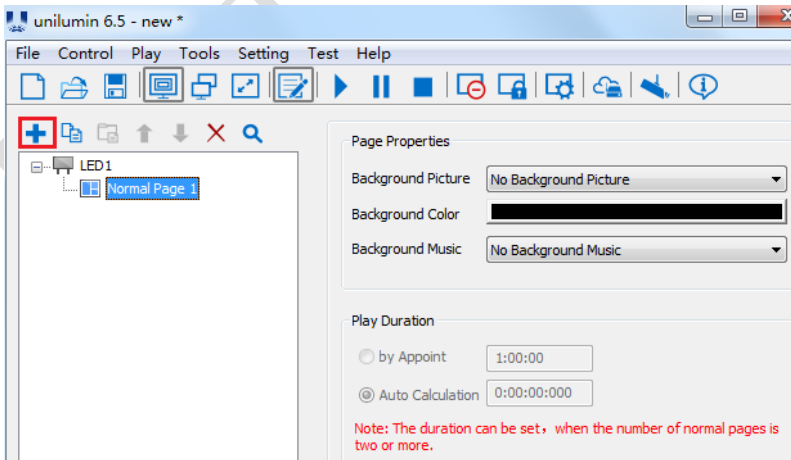



Fig 4-32 Adding New Program Page

- 2) After creating the program page, click the Add button  or right click on the program page node to bring up the add program window menu.

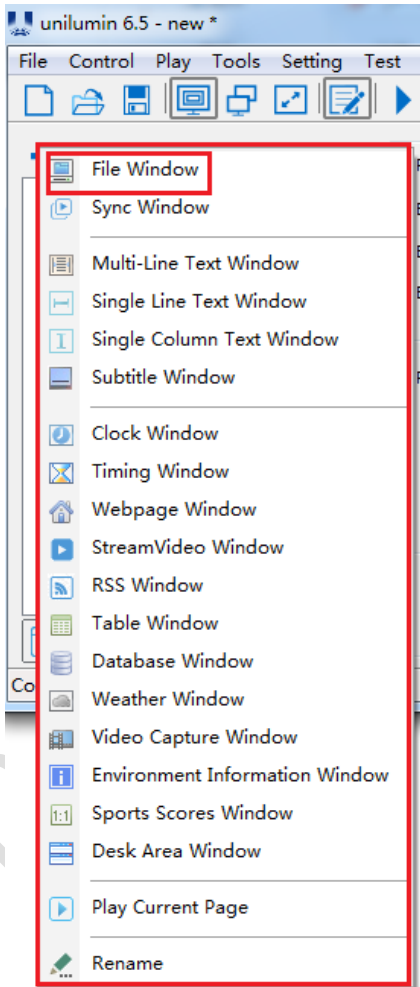



Fig 4-33 Add Program Window Menu

- 3) After adding the file window, select the file window and click the Add button  to select the desired material.

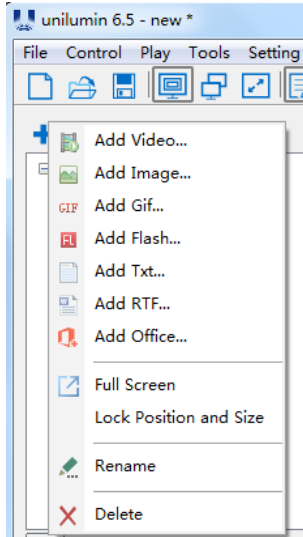

Fig 4-34 Material Menu

- 4) After adding the material, can set the material properties in the property box, as shown below:

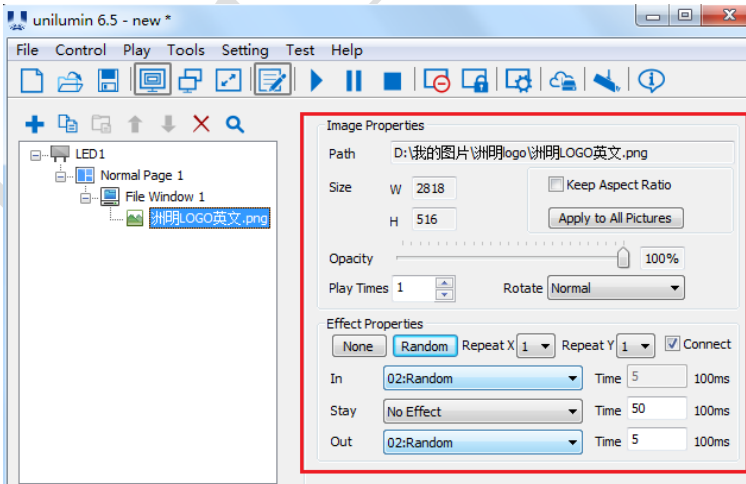

Fig 4-35 Display Setting Interface

4.2.3 Adjust Window Position and Size

Method One: Select the play window and then drag the mouse to adjust its size and position.

Method Two: Set it in the window properties, as shown below:

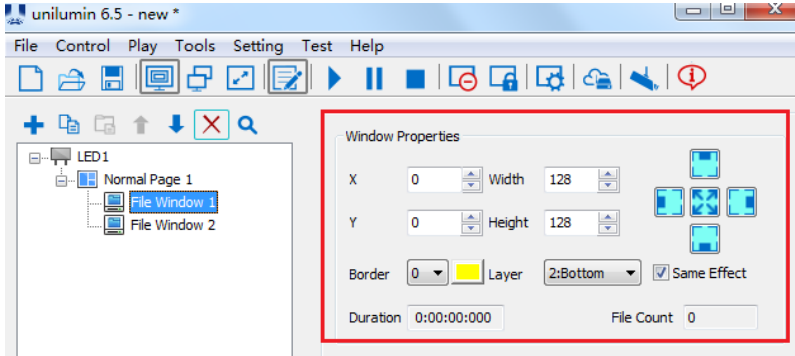

Fig 4-36 Window Properties

The coordinate X: It lies on the top left corner of the window in pixels, which is accordingly on the left boundary of the LED screen.

The coordinate Y: It lies on the top left corner of the window in pixels, which is accordingly on the upper boundary of the LED screen.

Width: The width of the window in pixels.

Height: The height of the window in pixels.

Window operation icon: For window shortcuts, there are left, right, top, bottom, and maximize.

Border: To set the width of the window border line in pixels.

Color: To select the color of the window border line.

Layer: The window in the program page has a hierarchical position relationship, and “1: top” is for the most front.

Same Effect: The files in the window are played with the same special effects. Get rid of this check, you can set different effects. If checked, the image in the file window can be set to different duration and special effects.

Duration: The time is required for all programs to play in this window.

File Count: The number of programs within this window.

4.2.4 Playing the Program

- 1) Play the current program file, click the play button  or click the main window "Play" → "Play" to start playing.

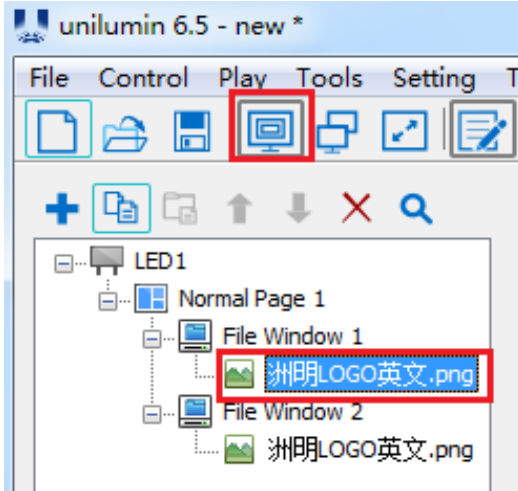

Fig 4-37 Play the Current Program File

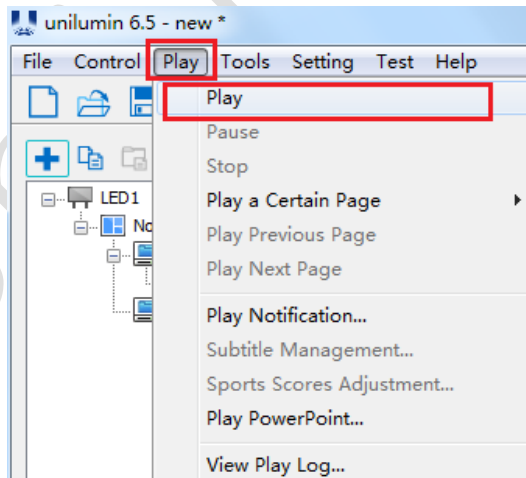

Fig 4-38 Play the Current Program File

- 2) Play multiple programs at the same time: Set the playback content, click the program page that want to play or click the “File” → “Open” button to open the file that want to play, then click “Play” → “Play” to play multiple programs. The program plays as shown in the figure:

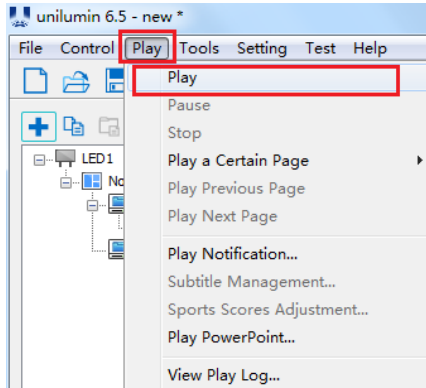



Fig 4-39 Play Setting



Fig 4-40 Program Plays

4.2.5 Edit Window

- 1) Delete: Select the material/window to be deleted, click the delete button  to delete the material/window; or right click on the material/window to be deleted, and in the pop-up options, click “Delete”, as shown below:

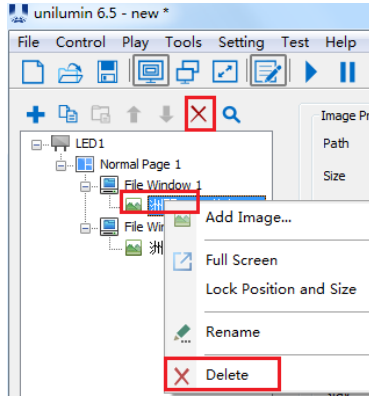



Fig 4-41 Delete

- 2) Copy: Select the window that want to copy, click the Copy button , click the copied location, and click the Paste button .

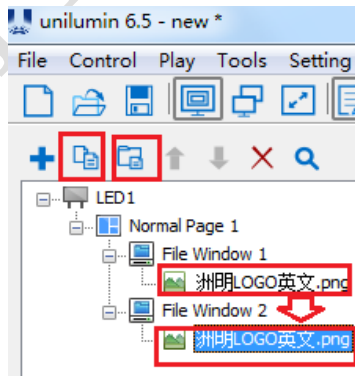



Fig 4-42 Copy

- 3) Save: After making the desired program page, click the button  to save the button or click “File” → “Save” to save the program.

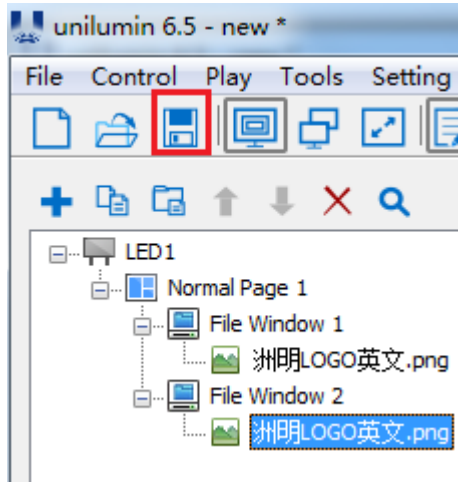

Fig 4-43 Save

4.2.6 Timed Playback and Control

- 1) Click “Control” → “Timing Command List” to enter the timing instruction list window;
- 2) Click “Add...” to add an instruction. In the “Timing Command List” window, set the execution content and time of the instruction. If there are multiple instructions, repeat the operation.
- 3) The details of the instructions include: play, pause, play program, power on LED display, power off LED display, show on LED display, show off LED display, set brightness, show LED play screen, hide LED play screen, restart this application, close this application, restart computer, shut down computer.

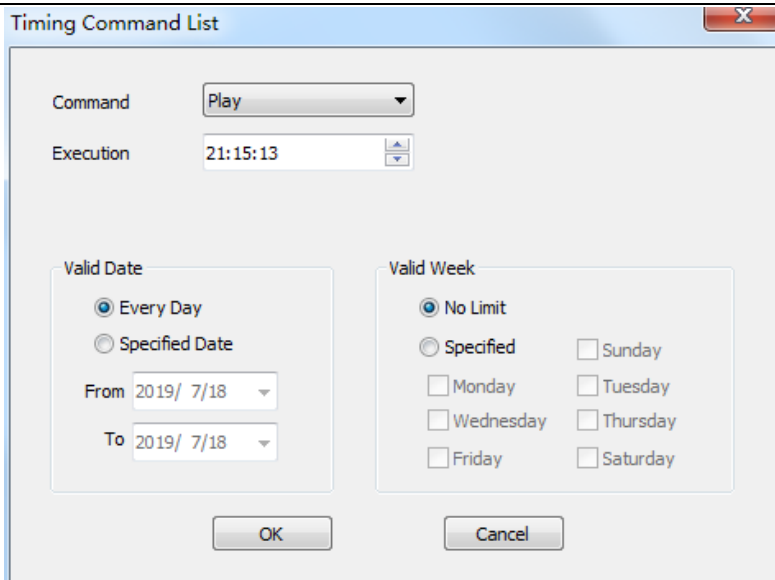

Fig 4-46 Timing Command List

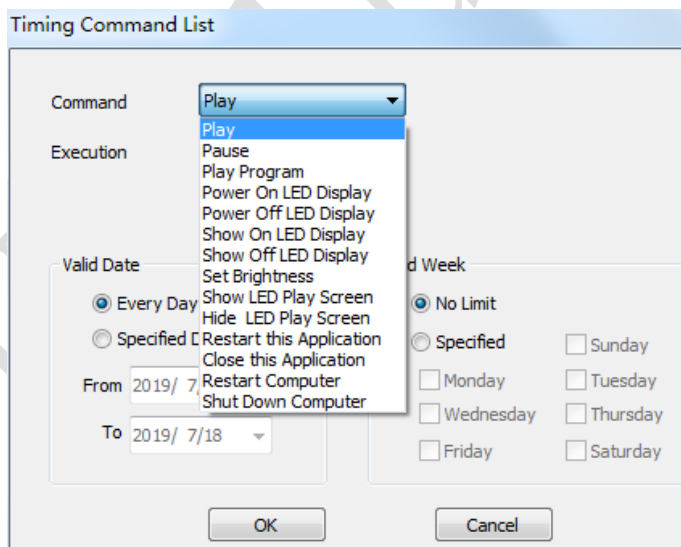

Fig 4-47 Setting Timing Command List

Chapter 5 Startup, Shutdown, and Maintenance

5.1 Startup Sequence

- 1) Start the distribution box for the LED display.
- 2) Start the control computer.
- 3) Start the video processor.
- 4) Start the sending box.

5.2 Shutdown Sequence

- 1) Shut down the video processor.
- 2) Shut down the sending box.
- 3) Shut down the control PC.
- 4) Shut down the distribution box for the LED display.

5.3 Daily Maintenance

- 1) Check whether ambient temperature and humidity meet the operating conditions for the LED display on a daily basis.
- 2) Use the LED display and its auxiliary devices at least twice a week and two hours each time. Before using the LED display, perform warm-up operations if it has been idle for 14 days (for details about warm-up operations, see Section 5.4).
- 3) It is recommended that you should use a soft antistatic brush to clear dust on the screen surface monthly in order to achieve an optimum displaying effect.
- 4) Check the parts in the distribution box quarterly. Check whether the power cables and signal cables for the LED display are connected securely and safely, and whether the display is grounded reliably.
- 5) Check whether the steel structure is secure on a yearly basis.

5.4 Warm-up Operation

If the LED display has been idle for 14 days, perform warm-up operations before using the LED display.

Set the prestored picture as follows when you initially start the LED display. This setting is for warm-up operation only. You do not need to set the prestored picture if the LED display is used frequently.

5.4.1 Unilumin N series - Setting the Prestored Picture

For details about how to set the prestored picture, refer to Section 3.6. Select a black background picture. Set **Boot Screen** to 60 seconds. Set both **Cable Disconnect** and **No DVI Signal** to **Prestored Picture**. Then click **Save to Hardware**. See Fig 5-1.

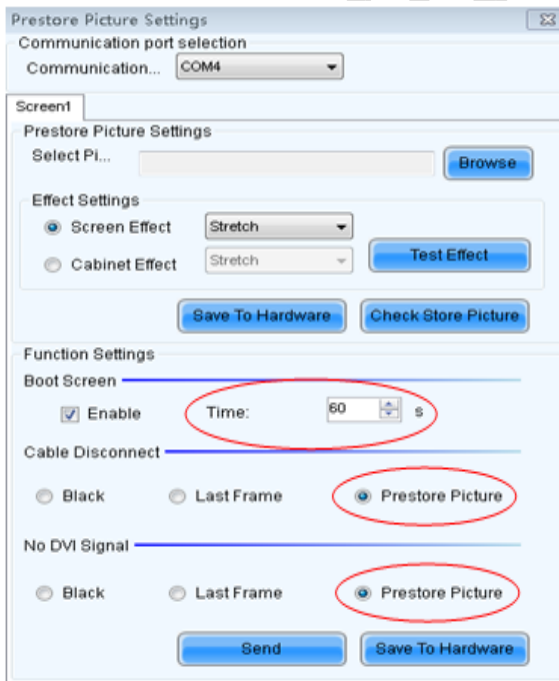

Fig 5-1: Prestore Picture Setting

5.4.2 Unilumin N series - Ageing Operation

On the main window, click **Brightness** to enter the brightness adjustment interface, as shown in Fig 5-2:

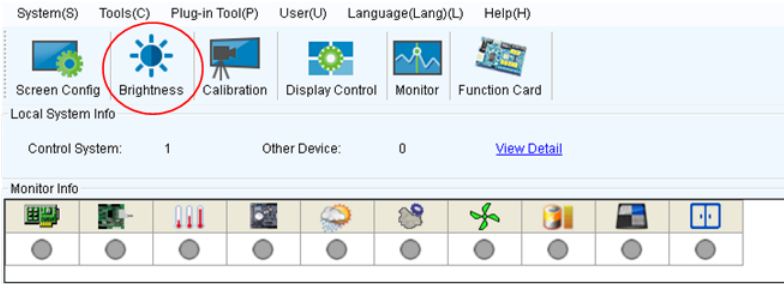

Figure 5-2 Main Window for Advanced User

Select **Manual** and set the brightness to 26 (the brightness is about 10%) by dragging the scroll bar below **Brightness Adjustment**. See Fig 5-3:

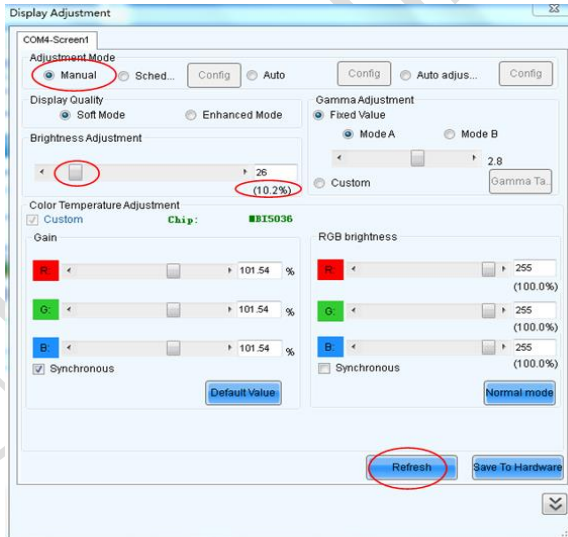

Fig 5-3 Manual Adjustment

NOTE: It is recommended that manual brightness adjustment be finished within 60 seconds.

Return to the main window. Click **Display Control** to enter the **Screen Control** interface. Set **Self Test** to **White**. Click **Send** to finish the operation. As showed in Fig 5-4 and Fig 5-5.

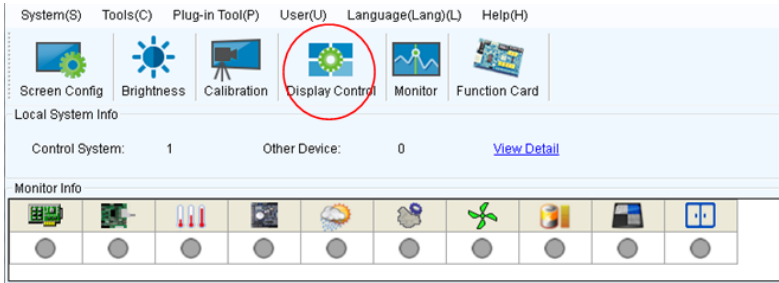

Fig 5-4 Display Control

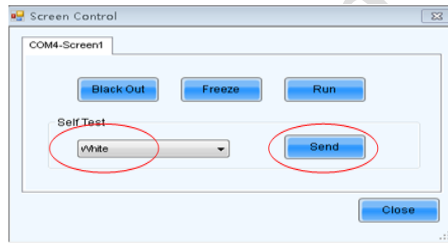

Fig 5-5 Display Control

Adjust the screen brightness and perform ageing based on the steps described in Section 5.4.2.

SN	Display Brightness	Ageing time
1	10%	1 h
2	30%	2 h
3	60%	2 h
4	80%	2.5 h
5	100%	0.5 h

5.4.3 Unilumin K series - Ageing Operation

If the display is not used for 14 consecutive days, please follow the instructions below for aging before using it again.

In the main window, click "Test" - "Aging Test" to enter the aging interface. Drag the playback window on the software to the display area of the display.

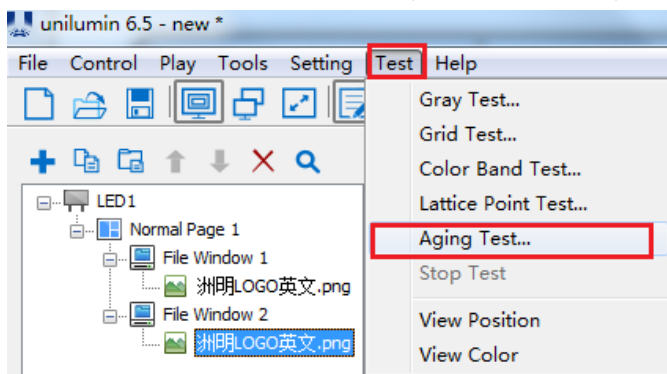

Fig 5-6 Aging Test

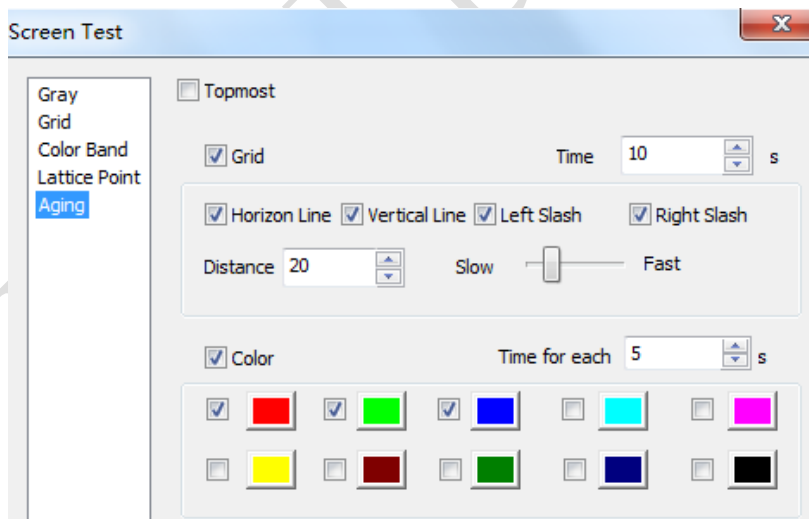

Fig 5-7 Screen Test

Chapter 6 Troubleshooting and Component Replacement

6.1 Common Faults and Troubleshooting Methods

6.1.1 Failure in Lighting up the Display

Causes:

- 1) No power is supplied to the display or the control devices.
- 2) The LED display does not have input signals.
- 3) The control PC is in sleep mode or the graphics card is set incorrectly.

Troubleshooting method:

- 1) Check AC power input of the display and the control devices.
- 2) Check cables between the sending box and the receiving card. Check whether the DVI cable between the control PC and the sending box is connected reliably.
- 3) Check whether the control PC is in sleep mode or monitor protection mode. If the control PC is not in sleep mode, check whether the graphics card is configured properly on the software.

6.1.2 Incomplete Picture or Incorrect Position of Picture Displayed

Causes:

- 1) The connecting file for the screen is incorrect.
- 2) Receiving card signal cables between cabinets do not contact properly.
- 3) The displaying position and screen size are set incorrectly.

Troubleshooting method:

- 1) Check whether the display's signal cable connection method is same to that of the loaded file xxxx.scr.
- 2) Check whether the signal cable is connected to the cabinet receiving card. If the receiving card is faulty, replace the receiving card.
- 3) Check whether Displaying Position and Screen Size on the software are set to actual screen size.

6.1.3 Screen Blinking

Causes:

- 1) The ports on the sending box are loose, or the signal cables are too long.
- 2) The output resolution of the playing device or sending box is set incorrectly.

Troubleshooting method:

- 1) Check whether the DVI cable and signal cable are connected to the display and devices, or whether the length of signal cables exceeds the maximum transmission distance (the effective transmission distance shall not exceed 10 m for DVI cable, 100 m for signal cable, 300 m for multi-mode optical fiber, and 15 km for single-mode optical fiber).
- 2) Check whether the resolution of the playing device and the sending box is greater than or equal to the resolution of the screen.

6.1.4 Blinking of a Cabinet in the Display

Causes:

- 1) The output of receiving card or hub card is faulty.
- 2) The receiving card program is incorrect.

Troubleshooting method:

- 1) Check whether the receiving card signal cable and hub card in the cabinet are connected correctly.
- 2) Check the receiving card program for the cabinet or check the receiving card.

6.1.5 Failure in Lighting up of a Cabinet in the Display

Causes:

- 1) The power supply, receiving card, or hub card for the cabinet is faulty.
- 2) Signal output of the previous cabinet is faulty.

Troubleshooting method:

- 1) Check voltage at the DC side of the power supply and the receiving card power supply. Check the receiving card signal indicator light in the cabinet. Check whether the hub card contacts properly with the receiving card.
- 2) Check output signals of the receiving card of the previous cabinet, or replace the signal cable.

6.1.6 Failure in Lighting up Part of the Modules in the Cabinet

Causes:

- 1) Output of the power supply for the modules is faulty.
- 2) Output of signal which controls the related modules is faulty.

Troubleshooting method:

- 1) Check DC voltage for the modules.
- 2) Check the hub card ports or flat cables that control the modules.



6.2 Replacement of Main Components

Before performing maintenance on the LED display, cut off the power supply to ensure your personal safety and equipment safety.

6.2.1 Replacement of Module



1) Front installing:

Cut off the power supply of the display , replace a module of the LED display based on the following steps:

Step	Picture	Description
1		Locate the faulty cabinet. remove the faulty module
2		Take out the faulty module and replace it with a new one.

2) Rear installing:

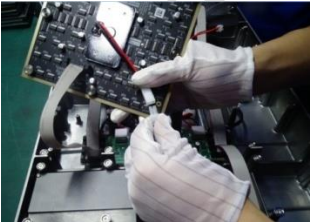

Replace a module of the LED display based on the following steps:

Step	Picture	Description
1		Locate the faulty cabinet. Disconnect the power cable and signal cable
2		Use a tool to suck out the faulty module
3		Take out the faulty module and replace it with a new one.

6.2.2 Replacement of Power Supply



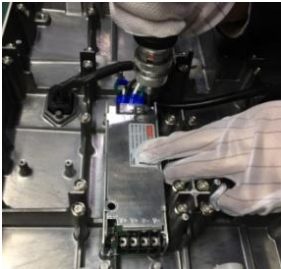

1) Front installing:

Cut off the power supply of the display , replace a power supply of the LED display based on the following steps:

Step	Picture Instruction	Operation
1		Locate the faulty cabinet. remove the faulty module
2		Locate the faulty power supply, remove the fixed screws of the power cable and the fixed screws of the power supply
3		Take out the power supply .Replace the power supply with a new one.

2) Rear installing:

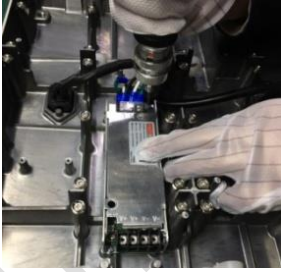
Replace a power supply of the LED display based on the following steps:

Step	Picture Instruction	Operation
1		<p>Locate the faulty cabinet. Disconnect the power cable and signal cable</p>
2		<p>Use a tool to suck out the faulty module</p>
3		<p>Locate the faulty power supply, remove the fixed screws of the power cable and the fixed screws of the power supply</p>
4		<p>Take out the power supply .Replace the power supply with a new one.</p>

6.2.3 Replacement of Receiving Card



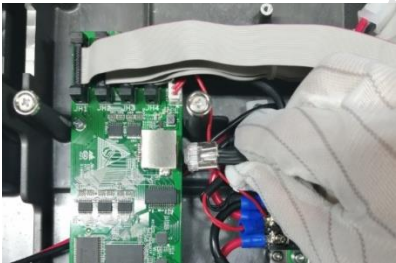
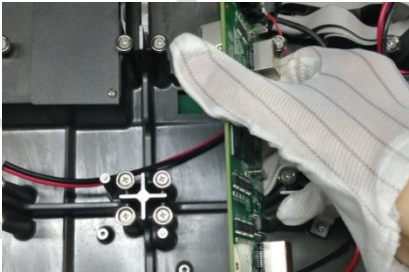

1) Front installing:

Cut off the power supply of the display , replace receiving card of the LED display based on the following steps:

Step	Picture Instruction	Operation
1		Locate the faulty cabinet. remove the faulty module
2		Disconnect the wire connected to the receiving card and remove the fixing screw of the receiving card.
3		Replace the receiving card with a new one

2) Rear installing:

Replace receiving card of the LED display based on the following steps:

Step	Picture Instruction	Operation
1		<p>Locate the faulty cabinet. Disconnect the power cable and signal cable</p>
2		<p>Use a tool to suck out the faulty module</p>
3		<p>Disconnect the wire connected to the receiving card and remove the fixing screw of the receiving card.</p>
4		<p>Replace the receiving card with a new one</p>

Chapter 7 Packaging Transportation and Storage

7.1 Packaging

The UHWII series products would be packed in carton, and the carton is vacuum-packed in an anti-static bag, and finally packed in heavy-duty carton, as shown below:



Figure 7-1 Package in Carton



Figure 7-2 Package in Heavy-Duty Carton

7.2 Transportation

The cabinets must be packaged before transportation. The product shall not be placed upside down or horizontally, and must be protected against the wind, rain, direct sunlight, and corrosive liquid during transportation. The stacking layers shall not exceed three layers for plywood cases.

7.3 Storage

The cabinets shall be stored in an environment with an ambient temperature ranging from -20°C to +55°C and a relative humidity ranging from 10% to 85% RH. Do not store the cabinets in an environment with volatile, corrosive, or flammable chemical products.

Chapter 8 After-Sales and Warranty

8.1 Warranty Scope

This Warranty Policy applies to LED display products (hereinafter referred to as “Products”) purchased directly from Unilumin Group Co., Ltd. (hereinafter referred to as “Unilumin”) and within Warranty Period. Any products not purchased directly from Unilumin does not apply to this Warranty Policy.

8.2 Warranty Period

The warranty period shall be in accordance with the specific sales contract. Please make sure warranty card or other valid warranty documents are in safekeeping.

8.3 Warranty Service

Products shall be installed and used strictly aligned with the Installment Instructions and Cautions for Use stated in the product manual. If Products have defects of quality, materials, and manufacturing during normal use, Unilumin provides warranty service for Products under this Warranty Policy.

8.3.1 Warranty Service Types

1) Online Remote Free Technical Service:

The remote technical guidance provided through instant messaging tools such as telephone, mail, and other means to help solve simple and common technical problems. This service is applicable for technical problems including but not limited to the connection issue of signal cable and power cable, system software issue of software use and parameter settings, and replacement issue of the module, power supply, system card, etc.

2) Return to Factory Repair Service:

For problems of Products that cannot be solved by online remote service, Unilumin will confirm with the customers whether to provide returning to the factory repair service. If factory repair service is needed, customer shall bear the freight, insurance, tariff and customs clearance for return delivery of the returned products or

parts to Unilumin's service station. And Unilumin will send back the repaired products or parts to customer and only bear one-way freight. Unilumin will reject unauthorized return delivery via pay upon arrival and will not be liable for any tariffs and custom clearance fees. Unilumin shall not be held liable for any defects, damages or losses of the repaired products or parts due to transportation or improper package.

3) Provide On-site Engineer Service for Quality Issues:

If there is a quality issue as stipulated in Article 5 of this Warranty Policy, and Unilumin believes the condition is necessary, on-site engineer service free of charge will be provided. In this case, customer shall provide a fault report to Unilumin for on-site service application. The content of the fault report shall include but not limited to photos, videos, number of faults, etc., to enable Unilumin to conduct preliminary fault judgment. If the quality problems is not covered by this Warranty Policy after the on-site investigation of Unilumin's engineer, customer shall pay travel expenses and technical service fees as per Article 7.4. Defective parts replaced by Unilumin's on-site engineers shall be the property of Unilumin.

8.4 Disclaimer

No warranty liability shall be assumed by Unilumin for defects or damages due to the following conditions:

- 1) Unless written agreed otherwise, this Warranty Policy does not apply to consumables, including but not limited to connectors, networks, fiber optic cables, cables, power cables, signal cables, aviation connectors, and other wire and connections.
- 2) Defects, malfunctions or damages caused by improper use, improper handling, improper operation, improper installation/disassembly of the display or any other customer misconduct. Defects, malfunctions or damages caused during transportation.
- 3) Unauthorized disassembly and repair without permission of Unilumin.
- 4) Improper use or improper maintenance not in accordance with the product manual.
- 5) Man-made damages, physical damages, accident damages and product misuse, such as component defect damage, PCB board defect, etc.

- 6) Product damage or malfunction caused by Force Majeure Events, including but not limited to war, terrorist activities, floods, fires, earthquakes, lightning, etc.
- 7) The product shall be stored in a dry, ventilated environment. Any product defects, malfunctions or damages caused by storage in an external environment that does not comply with the product manual, including but not limited to extreme weather, humidity, salt haze, pressure, lightning, sealed environment, compressed space storage etc.
- 8) Products used in conditions not meeting product parameters including, but not limited to lower or higher voltage, extreme or excessive power surges, improper power conditions.
- 9) Defects, malfunctions, or damages caused by non-compliance with technical guidelines, instructions, or precautions during the installation.
- 10) Natural loss of brightness and color under normal conditions. Normal degradation in the performance of the Product, normal wear and tear.
- 11) Lack of necessary maintenance.
- 12) Other repairs not caused by product quality, design, and manufacturing.
- 13) Valid warranty documents cannot be provided. Product serial number is torn or damaged. Product shell or other external parts are damaged.
- 14) Repairs after Warranty Period.
- 15) Products which have too significant damages caused by mishandling, accidents, improper maintenance, and failure to comply with product manual to be prepared.
- 16) Products malfunctions caused by unmatched play or control devices that are not provided by Unilumin. If Products are damaged arising out of the aforementioned unmatched devices and require Unilumin's repair, charging rate shall be as per Article 7.4.

8.5 Warranty Service Process

1) Remote Service Process:

Submit service requirements through website, email, telephone and other service channels of Unilumin with warranty card or contract number. Specific content of the service and contact information shall be provided.

2) Product Return to Repair Process:

Submit service requirements through the website, email, telephone and other service channels of Unilumin with warranty card or contract number. Packing list of the returned product and postal information to receive the repaired product shall be provided.

Unilumin's postal information is stipulated in Article 11.

Customer instructions:

- a) Shall provide a brief fault report (can be attached to the surface of the repaired item)
- b) Shall provide packing list (including contract number, model and quantity of the repaired item)
- c) Shall provide receipt postal information (company name, address, consignee, contact information, etc.)
- d) To avoid damages of the returned products during transportation, please be cautious about the package and protection of the products. Unilumin is not responsible for any damages to the returned products or parts during delivery.

3) On-site Engineer Service Process:

Submit service requirements through the website, email, telephone and other service channels of Unilumin with warranty card or contract number. Service content, site address, contact information, and visa application information shall be provided.

8.6 Other

This Warranty Policy is a standard application of Unilumin. No other third party (including any agent, distributor or sales representative) is authorized to make any representations or warranties that are different from this Warranty Policy. Unless otherwise confirmed by Unilumin in written forms of contract or other documents, any warranty clauses that conflict with this Warranty Policy shall be deemed to be automatically invalid. Final power of interpretation of this Warranty Policy shall be vested in Unilumin.

Attachment 1 - Path of Signal Cable inside the Cabinet

Cabinet Cable Connection Diagram of UHWII (Front View)

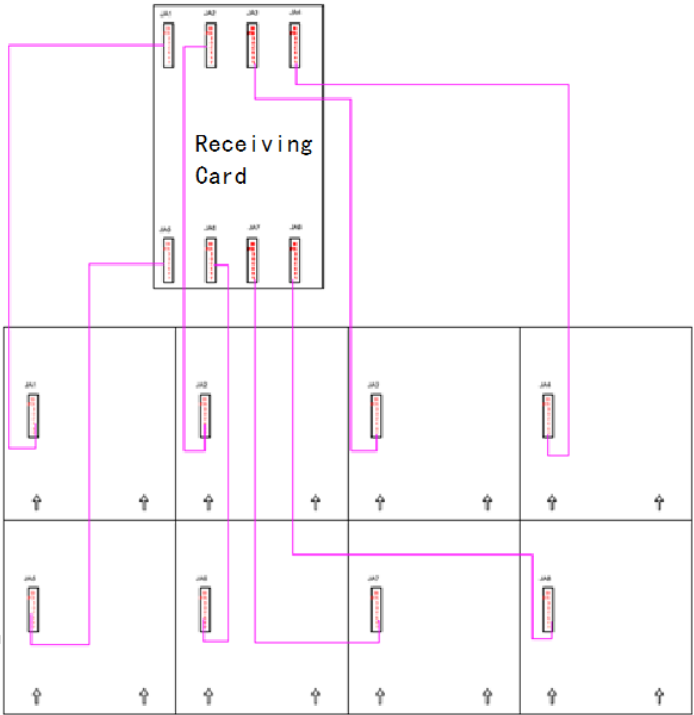



Contact Information

Shenzhen Headquarters

Headquarter Address: No. 112 Yongfu Road, Qiaotou Community, Fuyong Street, Bao'an District, Shenzhen

Pingshan manufacturing center: No. 6 North Lanjing Road, Pingshan New District, Shenzhen.

Daya Bay manufacturing center: Longsheng Fifth Road, western Daya Bay, Huiyang District, Huizhou.

Telephone (switchboard): + 86- (0) 755-29918999

Fax: + 86- (0) 755-29912092

Website: www.unilumin.com

Service Department Tel: + 86- (0) 755-29592226 (direct line)

24-hour service hotline: 400-677-3888

Display sales department

International department (direct line): + 86- (0) 755-29918999

E-mail: sales@unilumin.com

Customer Service Center

Tel: +86-(0)755-89318939(direct line) 29918999-8806 (extension)

E-mail: Customer-service@unilumin.com

Hotline: 400-677-3888

Contact Information

UNILUMIN USA LLC

USA HQ Address: 254W 31st St. 12th Floor, New York, NY 10001

E-mail: service@unilumin-usa.com

Tel: 001 844 263 3675

EUROPAN SERVICE CENTER

Address: Parellaan 28, 2132 WS, hoofddorp, the Netherlands

E-mail: euro-support@unilumin.com

sales@unilumin.com

Tel.: +31(0)20 214 9657

UNILUMIN UK CO. LIMITED

Address: Profile West, 950 Great West Road, Brentford, Middlesex TW8 9ES

E-mail: sales@unilumin.com

Tel: +44 (0) 208 568 6333

RUSSIA POST-SALE SERVICE CENTER

Address: Russia, 111250, Moscow, Zavoda Serp I Molot Drive, D.10

Tel: +86-755-29918999

SINGAPORE

Address: 10 Ubi Crescent #07- 36, Lobby B Ubi Techpark, Singapore 408564

E-mail: sales@unilumin.com

UNILUMIN GROUP CO., LTD (JAPAN)

Address: 6-chōme-104 Aioichō Naka-ku, Yokohama, Kanagawa, Japan

E-mail: sales@unilumin.com

UNILUMIN GERMANY GMBH

Address: Raiffeisenstr. 30 - 70794 Filderstadt

E-mail: info@unilumin.de

Tel: +49 711 38967 898

UNILUMIN AUSTRALIA PTY LTD (BUSINESS IN OCEANIA)

Address: Level 1, Trak Centre, 443/449 Toorak Road, Toorak, VIC 3142

Tel: +61 3 9006 8960

+86-755-29918999

+61 3 9827 8374

E-mail: amer-support@unilumin.com

sales_au@unilumin.com

MIDDLE EAST SUBSIDIARY

Address: Suite 1702, Reef Tower, cluster O, Jumeriah Lake Towers, Dubai, UAE

Tel: 00971 4 4270171

E-mail: sales@unilumin.com

SOUTH KOREA POST-SALE SERVICE CENTER

Address: 202 Room, Ye Sung Utopia 101, 186-7, Guro-dong, Guro-gu,

Tel: +010 8934 3547

E-mail: sales@unilumin.com

Unilumin

UNILUMIN GROUP CO.,LTD.



310-PUHWII-A5