

D

Amplifiers Software

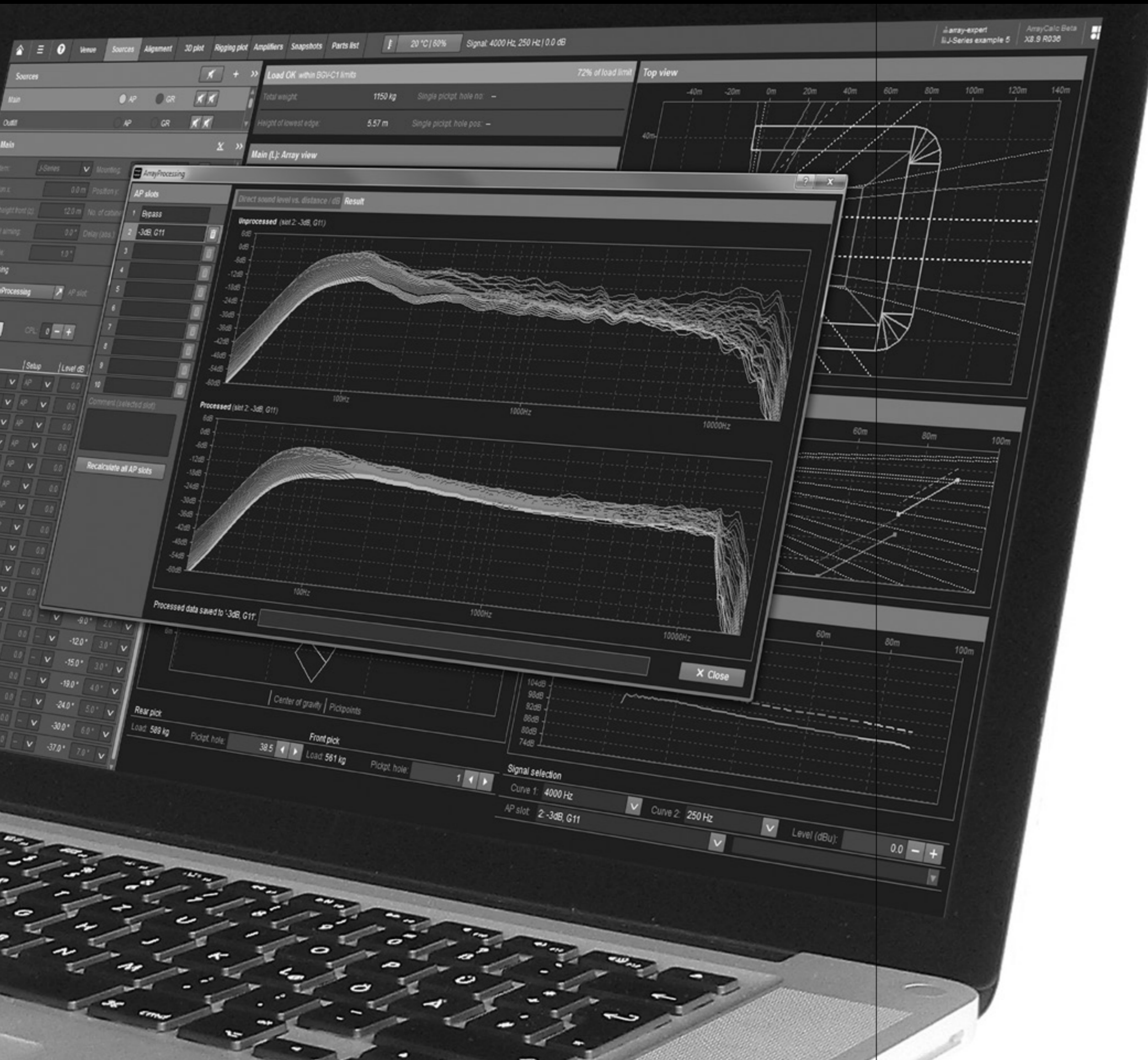

Contents



The d&b System reality	4
The d&b Workflow	6
The d&b ArrayCalc simulation software	8
The d&b NoizCalc immission modelling software	10
The d&b R1 Remote control software	12
The d&b Remote network topology	14
The DS10 and DS20 Audio network bridges	16
The DS100 Signal Engine	17
The d&b amplifiers	18
The D6 amplifier	24
The D20 amplifier	26
The D80 amplifier	28
The D20 and D80 Touring rack assemblies	30
The 6 x D80 Touring rack assembly	34
The cables and adapters	38
The amplifiers and software product overview	46

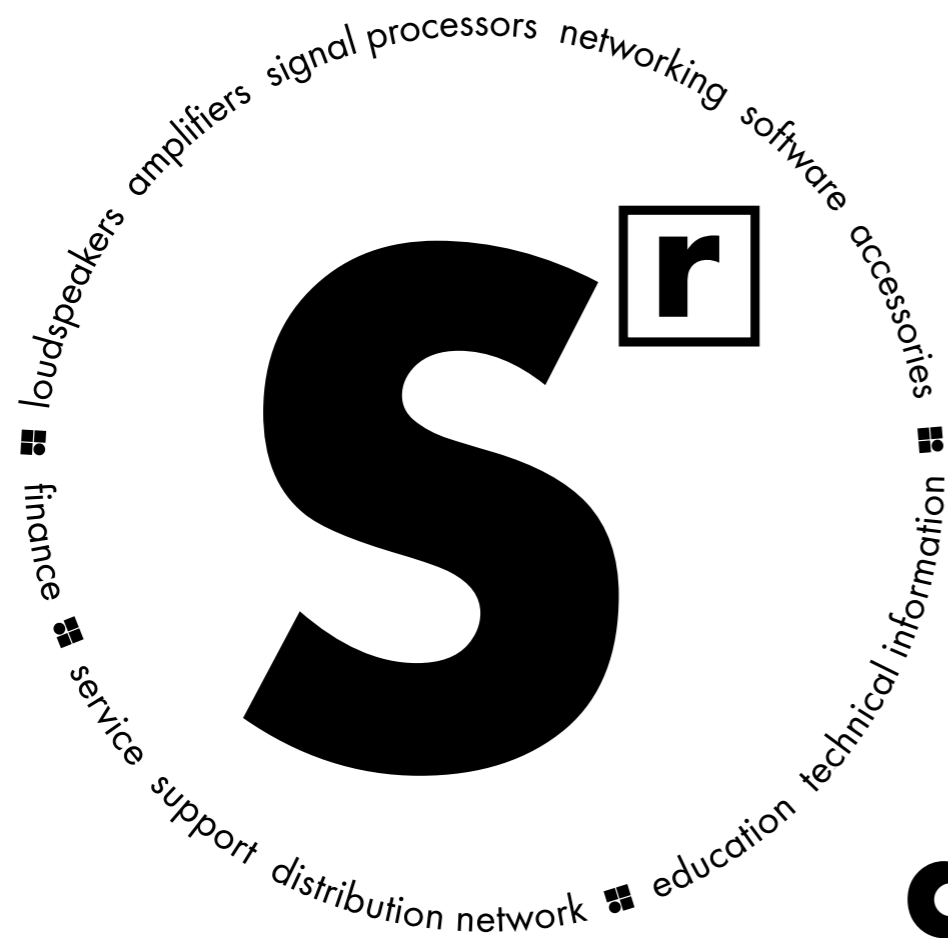

d&b System reality

As the name implies a d&b audiotechnik system is not just a loudspeaker. Nor is it merely a sum of the components: loudspeakers, amplifiers, signal processors, networking, software and accessories. Right from the outset the d&b audiotechnik approach was to build integrated sound reinforcement systems

that actually are more than the combination of parts: an entirety where each fits all. Every element is tightly specified, precisely aligned and carefully matched to achieve maximum efficiency. For ease of use, all the user-definable parameters are incorporated, allowing the possibility of adjustment, either

directly, via remote control surfaces, or integrated within wider networks. Neutral sound characteristics leave the user all the freedom needed to realize whatever the brief. At the same time d&b offers finance, service and support, a knowledgeable distribution network, education and training as well as technical

information, so the same optimal acoustic result is achieved consistently by every system anywhere, at any time. In reality: the d&b System reality.

The d&b Workflow

Planning and simulation

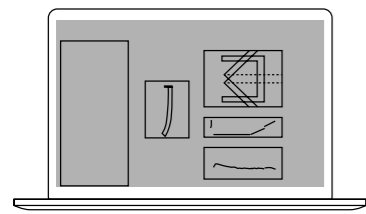

d&b ArrayCalc simulation software

Control and operation

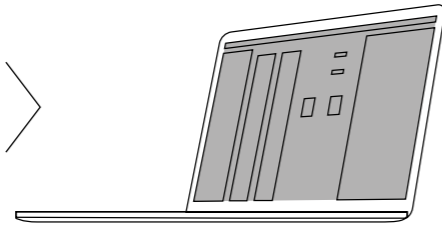

d&b R1 Remote control software

Processing and distribution

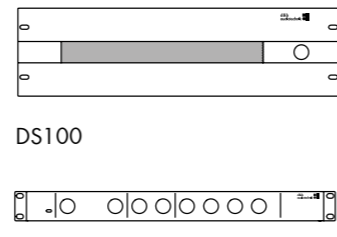

DS100

DS10 and DS20

d&b audio network devices

Management and amplification

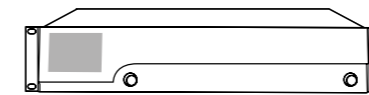

d&b amplifiers

Reproduction

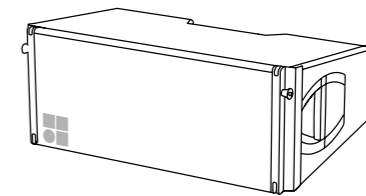

d&b loudspeakers

The integrated **d&b Workflow** improves efficiency all the way from the start of a project through planning and simulation to control of the final result. In the first stage of the d&b Workflow, a 3D model of a venue is created using d&b ArrayCalc, where loudspeakers can be virtually placed, positioned, and

configured. When this is completed the system performance can be simulated. Once the mechanical settings of a line array have been finalized the optional ArrayProcessing function within ArrayCalc can be applied. ArrayProcessing uses powerful filter algorithms to optimize the level and tonal balance of a line array

across the entire audience area. Once the desired performance has been achieved, the amplifiers can be configured and signal routing defined. ArrayCalc then generates rigging plans, parts lists, and graphics for use in the final proposal. In the next stage of the d&b Workflow, the file built by ArrayCalc can be opened

by the R1 Remote control software where a graphical user interface for the complete system is automatically generated. It is now that all of the settings defined in ArrayCalc can be sent to the amplifiers, and signal distribution configuration can be sent to Signal Engines or Audio Network Bridges.

The d&b ArrayCalc simulation software

The d&b ArrayCalc simulation software is the prediction tool for d&b systems. This is a comprehensive toolbox for all tasks associated with acoustic design, performance prediction, alignment, rigging and safety parameters. For safety reasons d&b line arrays must be designed using the d&b ArrayCalc simulation software. d&b ArrayCalc is available as a native stand-alone application for both Microsoft Windows¹ (Win7 64-bit or later) and Mac OS X² (10.12 or later) operating systems and is available at www.dbaudio.com, along with further information and video tutorials.

Simulation

Listening planes can be defined in the venue tab, creating a three dimensional representation of any audience area in a given venue. Special functions assist in obtaining accurate dimensions with laser distance finders and inclinometers. Flown arrays or subwoofer columns can be defined in a project file as single hangs or in pairs. Point source loudspeakers can also be fully integrated as well as a ground stacked SUB arrays. Level over distance is calculated for each source with high resolution in real time, for either band limited or broadband input signals. The comprehensive simulation precisely models the actual performance of the system, taking into account input level, all system configuration options (such as CUT, CPL, HFC or INFRA), limiter headroom and air absorption. Acoustic obstacles, such as video screens, can be added to a model. Acoustic shadowing, whether by these obstacles, or a balcony overhang, is taken into consideration. The load status of all array rigging components is calculated accurately and displayed to determine whether a given array is within the load tolerance. Subwoofer array design is assisted by coverage and polar plot prediction. A specialized algorithm allows the user to specify subwoofer positions and a coverage angle, which is then converted into appropriate delay settings that result in the desired dispersion. The alignment tab enables different sources to be time aligned to one another, as well as showing arrival times and Sound Pressure Levels at a definable reference point on one of the audience areas. For alignment of the flown system with the ground stacked SUB array, the phase response of both the SUB array and a flown source is calculated at a definable reference point. The level distribution resulting from the interaction of all active sources can be mapped onto the audience areas in a three-dimensional view. EASE and DXF data export capabilities are also available.

System setup

A rigging plot with all necessary coordinates, dimensions and weights of arrays is generated for export and printing and a parts list, detailing all components required. The d&b ArrayCalc Viewer app presents this key information for positioning and

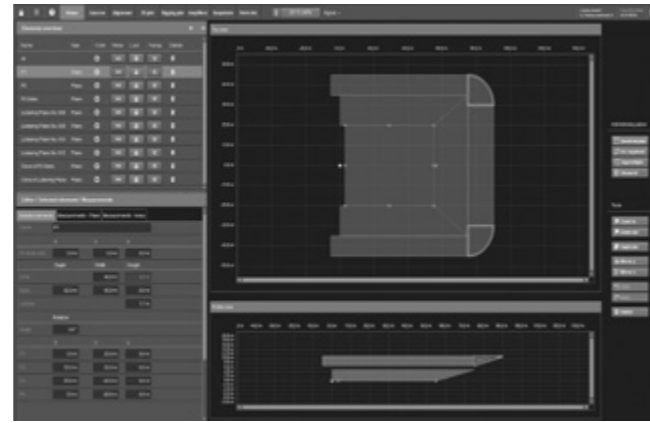

Venue

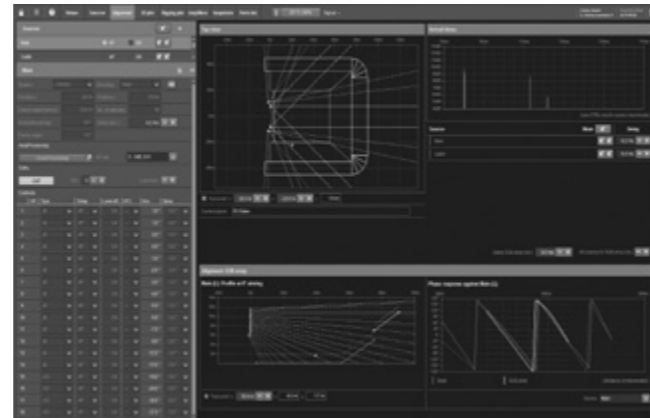

Alignment

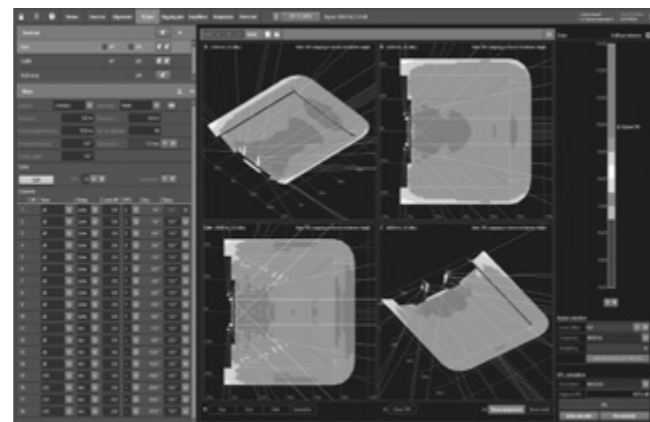

3D Plot quad

flying a d&b audiotechnik loudspeaker system on a mobile device. Once the system has been designed, calculated and optimized, the project files can be shared via email, AirDrop, or downloaded onto any iOS or Android device.

ArrayProcessing

The optional ArrayProcessing function applies powerful filter algorithms to optimize the tonal (spectral) and level (spatial) performance of a line array column over the audience area defined by its mechanical vertical coverage angle. Within the d&b ArrayCalc simulation software, spectral and level performance targets over the listening areas can be defined while specific level drops or offsets can be applied to certain areas, to assign reduced level zones. ArrayProcessing applies a combination of FIR and IIR filters to each individual cabinet in an array to achieve the targeted performance, with an additional latency of only 5.9 ms. This significantly improves the linearity of the response over distance as well as seamlessly correcting for air absorption. In addition, ArrayProcessing employs the same frequency response targets for all d&b line arrays, to ensure all systems share a common tonality. This provides consistent sonic results regardless of array length or splay settings. The resulting coverage is enhanced with spectral consistency and defined level distribution, achieving more linear dispersion and total system directivity to cover longer distances or steep listening areas effectively.

d&b Soundscape

The d&b ArrayCalc Software is also used for planning and simulation of d&b Soundscape. An Early reflections area can be defined in the Venue view, for which the En-Space software will calculate additional convolutions to better represent the early reflections of the original venue. Additionally Positioning areas can also be defined for use in combination with the En-Space software, which are used as a reference plane for positioning Sound objects either from R1 or via external controllers. The d&b Soundscape loudspeaker system is also planned, configured and simulated in ArrayCalc, with loudspeakers assigned to Function groups, for which the Soundscape algorithms calculate individual transfer functions according to their function within the system. DS100 Signal Engine devices can be added to a project, together with the necessary DS10 Audio network bridges. Signal routing can be defined for the whole signal path, from DS100 to loudspeaker, through the DS10 and amplifier devices. A Dante Controller preset file can be automatically generated in ArrayCalc, including the complete Dante routing for the whole system. This preset file can be later loaded in Dante Controller, so that no manual Dante patching is required.

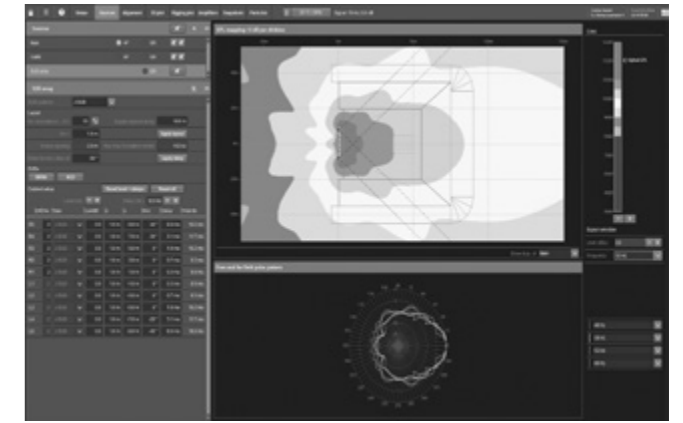

Sources, SUB array

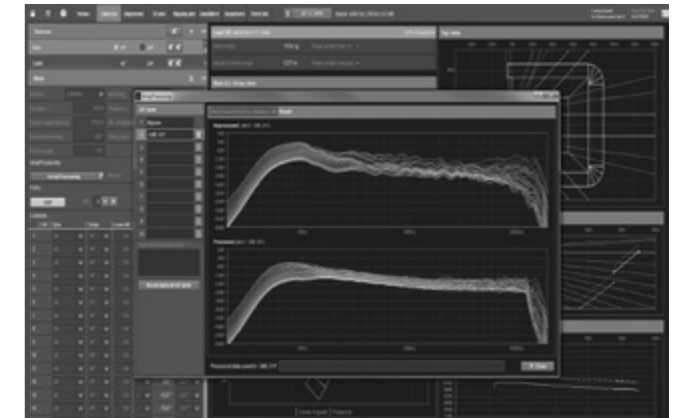

ArrayProcessing

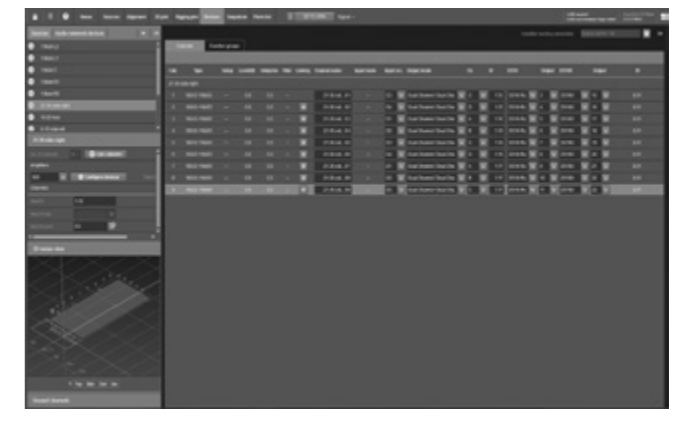

Devices

¹ Microsoft Windows is a registered trademark or trademark of Microsoft Corporation in the United States and/or other countries

² Mac OS X is a trademark of Apple Inc., registered in the U.S. and other countries

The d&b NoizCalc immission modelling software

The d&b software uses international standards to model the far field noise immission from multiple complex and coherently emitting sources such as line arrays and subwoofer arrays. More and more, gaining permission and licenses to stage live open air events requires an official statement with a prediction of how noise could impact on the surrounding area. NoizCalc takes all complex loudspeaker data and a reference point from the d&b ArrayCalc simulation software and calculates the sound propagation and relative attenuation values towards the far field for a certain scenario with particular meteorological conditions for one or more d&b loudspeaker systems.

A 3D terrain map imported from Google Maps or Street View displays the calculated immission on the areas surrounding the audience listening zones. This visual representation shows the actual system performance in the far field, enabling users to optimize for listeners while satisfying local noise restrictions and offsite regulations.

To ensure reliable results, NoizCalc includes all complex data concerning the addition and subtraction of sound waves, including phase information to describe the combination and interaction effects within a loudspeaker system consisting of multiple line arrays, subwoofer arrays and delay systems.

NoizCalc models immissions in the far field according to the internationally accepted ISO 9613-2 or Nord2000 calculation standards. Ground characteristics can be set depending on the absorbency or reflectivity of surfaces, while areas with volume attenuating properties can be defined. Buildings can be included, and the maximum reflection order option adjusts how many reflections are calculated. Parameters for humidity, air pressure and temperature ensure that the correct air absorption figures are accounted. The ISO 9613-2 standard requires limited meteorological information and assumes a worst-case scenario. The more sophisticated propagation model, Nord2000 enables a more precise handling of meteorological conditions allowing the user to model with prevailing wind information. The d&b NoizCalc immission modelling software is available at www.dbaudio.com for registered download, along with further information and video tutorials. It was developed in collaboration with SoundPLAN, a specialist software developer for environmental noise prediction.

Calculation

All complex loudspeaker data and the reference point is taken from ArrayCalc. NoizCalc then displays the modelled effects of the sound propagation and the resulting immission from the sound reinforcement system in the far field.

Modelling

Using 3D geographical data, mitigation areas such as woodland and solid obstacles can be added and modelled. NoizCalc displays the immission on a terrain map, presenting the calculated Sound Pressure Levels in dBA applying the selected frequency spectrum using either the ISO 9613-2 or Nord2000 standards. If Nord2000 is selected, additional meteorological data including wind direction, wind speed and temperature gradients can be included in the calculation.

Optimization

NoizCalc is intended to optimize the planning and design of a loudspeaker system. Any potential noise issues can be addressed by virtually modifying the system design, stage orientation or system settings, to achieve remarkable results for the audience with full consideration for the far field.

Monitoring

The results map displays the calculation in the far field according to the selected standard and associated parameters. An additional time histogram prediction and monitoring positions may still be required for official purposes. The NoizCalc results map will show the sound propagation and attenuation over distance. The system technician can then monitor the level at the reference point and assess the actual results at the monitoring positions while adapting specific meteorological or spectral variations. Comparing the calculated results with the actual measurement at the reference point will indicate how the system should be adjusted to meet offsite noise restrictions.

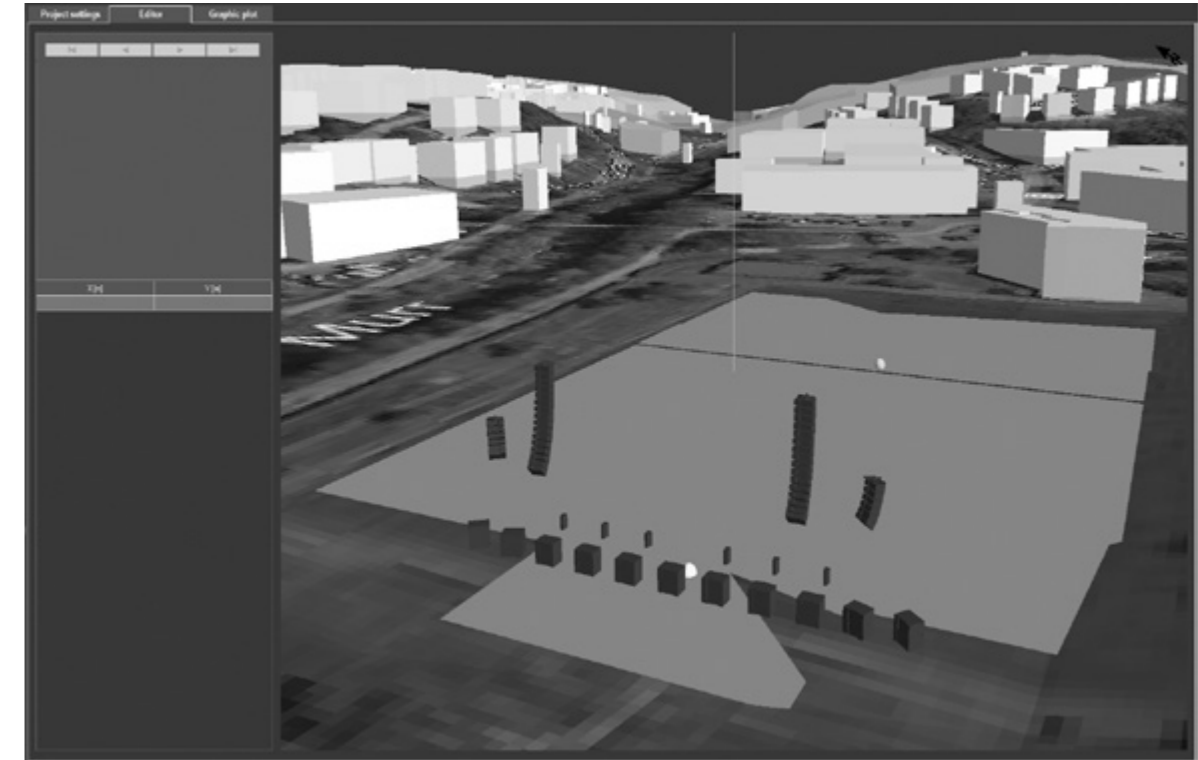

Editor



Graphic plot

The d&b R1 Remote control software

The remote control capability of the d&b Remote network enables central control and monitoring of a complete d&b loudspeaker system from anywhere in the network, be it from a laptop in the control room, at the mix position, or on a wireless tablet computer in the auditorium. In the typical user workflow, the d&b Remote network takes settings optimized in the ArrayCalc simulation software and applies these to all the d&b devices within the network. In mobile situations R1 Remote control software provides extensive functionalities for storing and recalling system settings, enabling setups to be repeated as and when required. Project files can be adjusted for use with different equipment at another location. d&b System check verifies that the system performs within a predefined condition, while the Array verification function automatically identifies the physical position of a loudspeaker in an array to check that the system is cabled correctly. For permanent installations, system integrators can configure the d&b Remote network to allow access to different levels of control, according to the operational needs of the venue, with password protection available to restrict access to advanced functions if necessary. R1 enables d&b devices to be remotely controlled, using both Ethernet (AES70/OCA) and CAN-Bus in parallel. The software runs on both Microsoft Windows¹ (Win7 64-bit or later) and Mac OS X² (10.12 or later) operating systems and is available at www.dbaudio.com, along with further information and video tutorials.

R1 Remote control software

The R1 Remote control software uses the same project file created in ArrayCalc to automatically generate an intuitive graphical user interface including complete details of the simulated system. This user interface can be customized by the user, in order to fit particular user needs. Changes to the project file can be performed at any time in both ArrayCalc and R1. This workflow removes the need to manually transfer data from one software program to the other.

All features, functions and controls from d&b devices can be remotely controlled and/or monitored using R1 Remote control software. It allows each channel of the amplifiers or the DS100 Signal Engine matrix to be controlled and enables the creation of groups of channels. When grouped together, a button or fader can control the overall system level, zone level, equalization and delay, system power ON/OFF, MUTE as well as loudspeaker specific function switches, such as CUT/HFA/HFC, CPL and ArrayProcessing. An offline mode is provided for preparation in advance of an event, without the need for physical devices being present or connected. The Home view provides an overview of all views in R1 and access to all user defined remote views. Each user definable Remote view can be populated with control



R1 home screen



R1 in configuration mode

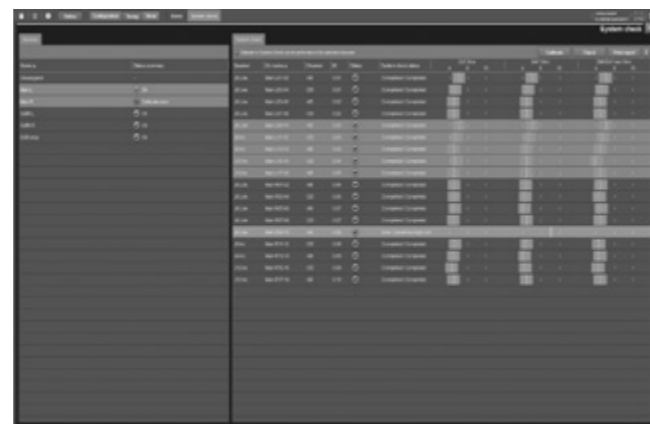

System check in R1

functions of the system and can be optimized for different screen resolutions, either for large monitors or for smaller tablet devices.

DS10 and DS20 Meta data

The DS10 and DS20 Audio network bridge sends Meta data to the d&b amplifiers via the AES3 channel streams. This information can be read remotely from R1, and includes channel subscription information, such as such as channel labels and network and redundancy status. Additionally, cabling information is also provided, which makes it possible to find possible cabling mistakes in the audio signal chain.

d&b Soundscape

After system planning and simulation in ArrayCalc, the d&b Soundscape is completely configured, monitored and controlled in R1. The DS100 Signal Engine matrix can be operated manually by the controls on the Device view tabs or, alternatively, by controls in a Remote view. The Matrix crosspoint control provides an array of level and delay controls for a user defined range of matrix crosspoints. Input and Output processing is also available, with a combination of Polarity, Level and Delay available on all inputs and outputs. Additionally, an 8-band parametric EQ is provided on all inputs, and a 16-band parametric EQ on all outputs. Special Positioning remote views can be created for En-Space systems, in which Sound objects can be individually placed within the venue. En-Space sampled spaces can be selected within R1 from the available library provided with the En-Space software license. En-Space levels for inputs and outputs can also be controlled within the Device or Remote views, and additional EQ for each of the four zones of the space is provided.

Service functions

R1 enables the simultaneous firmware update of multiple devices from a central location. The software will automatically search the d&b website and on demand, downloads the latest available firmware versions and R1 Remote control software updates. Defined settings can be created, saved on a computer and loaded into the devices, for example to ensure that configuration switches are set to a known status, or the user definable equalization is set flat. Settings can be copied to additional or spare devices. For service purposes, information may be read from a device, concerning its condition during operation and errors reported. When additional support is required, the error report can be saved and sent to the d&b service departments for further assessment and diagnosis.



D20/D80 16-band equalizer in R1

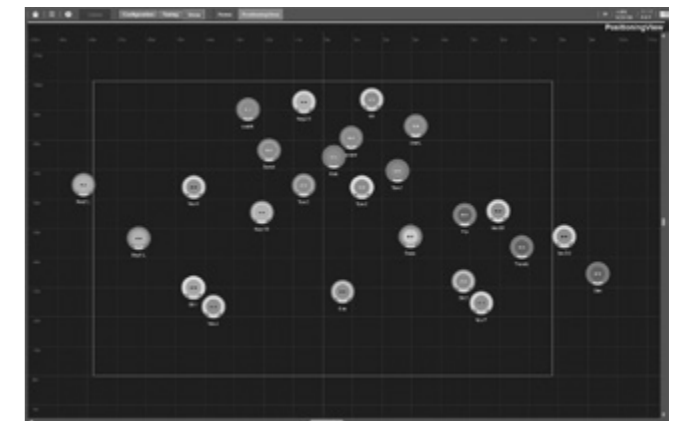

Positioning view in Soundscape

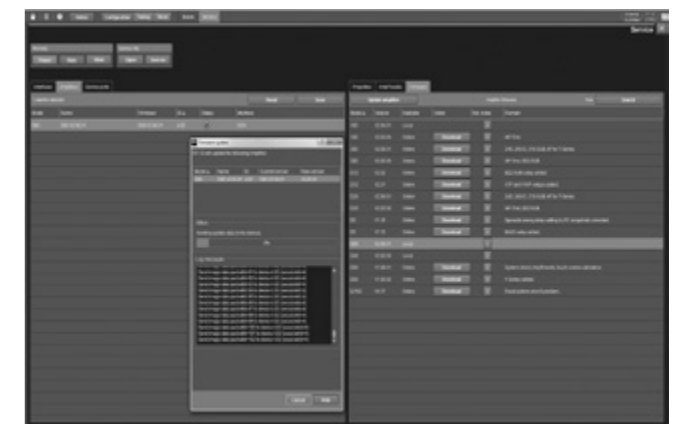

Service, Firmware update in R1

¹ Microsoft Windows is a registered trademark or trademark of Microsoft Corporation in the United States and/or other countries

² Mac OS X is a trademark of Apple Inc., registered in the U.S. and other countries

The d&b Remote network topology

The D20 amplifier and D80 amplifier can be remote controlled using the industry standard OCA protocol via Ethernet and through the established CAN-Bus, which can also control the D6 amplifier as well. d&b amplifiers are controlled using the d&b R1 Remote control software, which is available on both Windows and MAC operating systems. This Remote user interface can control the D20 and D80 amplifiers via Ethernet (OCA) and the D6 amplifier through CAN-Bus networks simultaneously. The D20 and D80 amplifiers also provide a web interface, offering access to individual D20 and D80 amplifiers through a web browser.

d&b Remote network – OCA via Ethernet

The D20 and D80 amplifiers can be remotely controlled via a standard Ethernet network, providing higher bandwidth and quicker response compared to the CAN-Bus network. This latest generation of d&b amplifiers are fitted with two etherCON¹ connectors, allowing simple networks to be set up, without requiring an extra switch. The industry standard Open Control Architecture (OCA) protocol is used, created by the OCA Alliance of which d&b is a founding member. For further information please refer to the d&b TI 310 Ethernet networking, which is available for download at www.dbaudio.com.

d&b Remote network – CAN-Bus

The d&b amplifiers can be integrated within the CAN-Bus network and are fitted with two REMOTE/CAN connectors (RJ 45) to link the CAN-Bus signal and enable daisy chaining. The network may contain any combination of up to a total of 504 devices. It is connected to a PC or MAC running R1 Remote control software V2, using R60 USB to CAN, or R70 Ethernet to CAN interfaces. While the CAN-Bus network covers distances up to 600 m the Ethernet connection to the R70 can be made using standard Ethernet technologies, including wireless or fibre optic networks. For further information please refer to the TI 312 d&b Remote network, which is available for download at www.dbaudio.com.

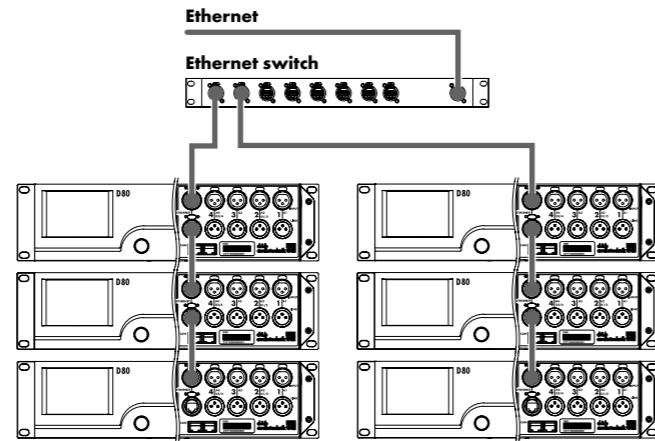

Combined Ethernet topology

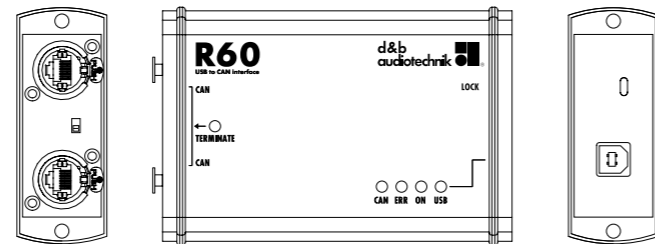

Z6118 R60 USB to CAN interface

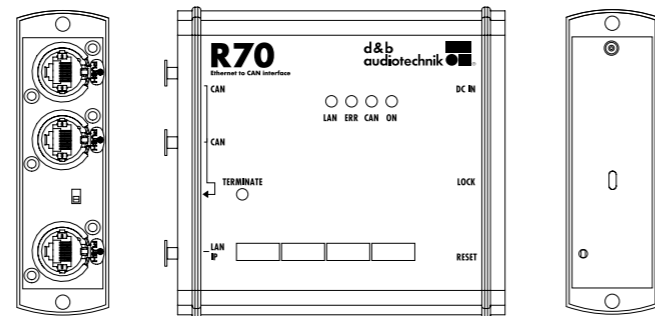

Z6124 R70 Ethernet to CAN interface

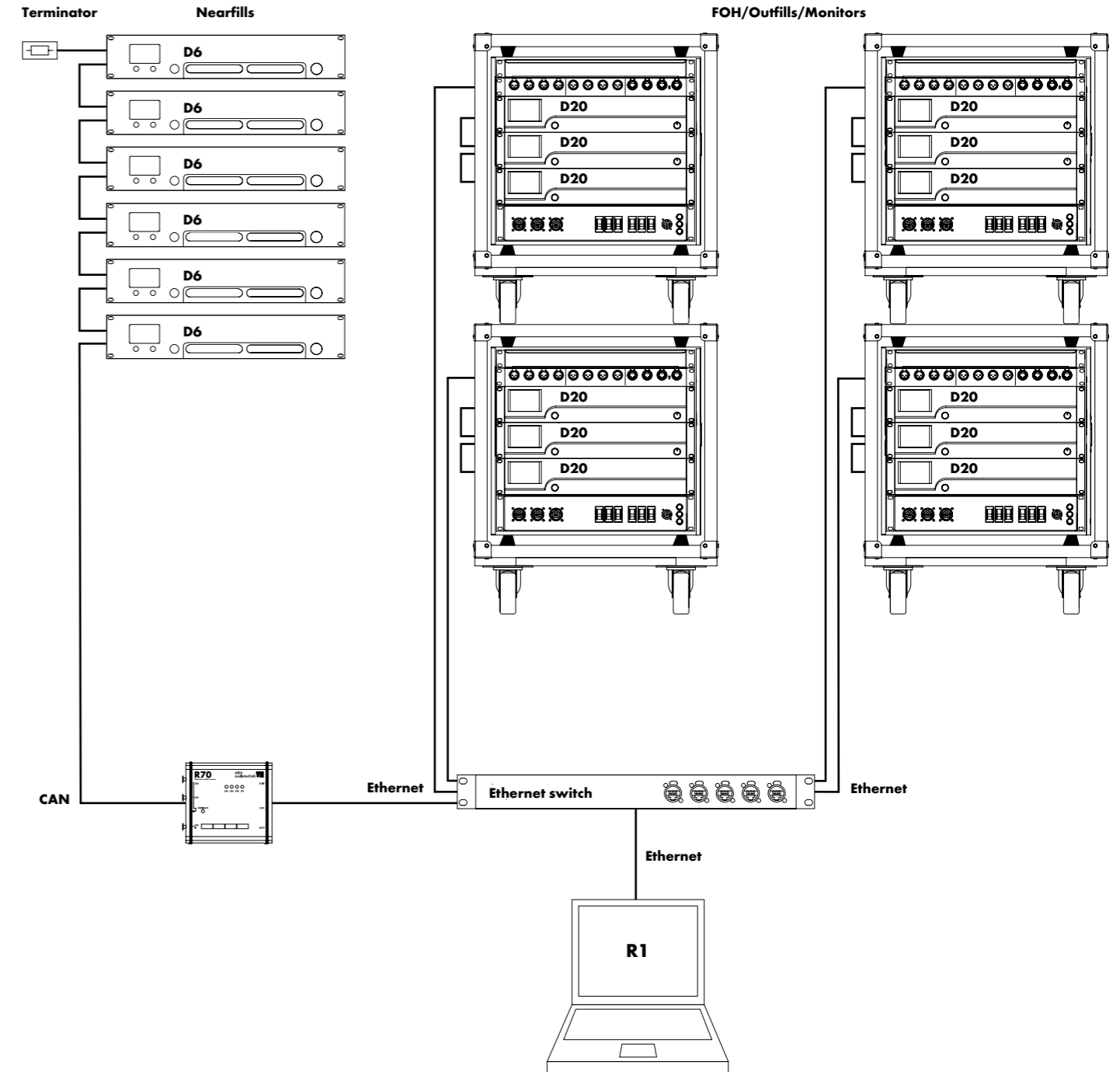

Mixed application with D20s driven via Ethernet and D6s via CAN-Bus and Ethernet

The DS10 and DS20 Audio network bridges

DS10 Audio network bridge

The DS10 Audio network bridge interfaces between Dante networks and AES3 digital audio signals, while also providing distribution of Ethernet control data. Positioned within the signal chain in front of the amplifiers, this 1 RU device expands the d&b system approach. Each unit can deliver up to sixteen Dante network channels via AES3 digital signal outputs. Additionally, four AES3 input channels provide access to the Dante audio network for applications such as a break-in from a Front of House console. The DS10 incorporates an integrated 5-port switch, offering a primary and redundant network for the Dante protocol, as well as advanced functions such as Multicast Filtering and VLAN modes. Using the DS10 Audio network bridge, audio signals and remote control data can be combined using a single Ethernet cable.



The DS10 Audio network bridge front view



The DS10 Audio network bridge rear view



The DS20 Audio network bridge front view



The DS20 Audio network bridge rear view

DS20 Audio network bridge

The DS20 Audio network bridge supports the open standards-based Milan protocol rather than Dante. Milan (Media integrated local area networking) is a high level interoperability solution based on Audio Video Bridging (AVB) technology. The main advantages are deterministic behaviour (zero network congestion); improved reliability; optimum synchronization and hassle free network setup, as no special settings, such as QoS, need to be set within the switches to ensure delivery.

The DS100 Signal Engine

The d&b Soundscape

The d&b Soundscape is the acoustic environment in context, as perceived, experienced and understood. It defines acoustic environments in which people feel performances, speeches and presentations, real or abstract. It introduces another dimension to the d&b system approach, aligning the aural and visual perception, either realistically, or imaginatively. The d&b Soundscape also includes functionality which can modify the acoustic environment by imposing a different reverberation signature in the audience area, whether inside or outside.

DS100 Signal Engine

The DS100 Signal Engine is the platform underneath the Soundscape, based on a specialized rack mount 3 RU audio processor with Audinate Dante networking. It provides a 64 x 64 audio matrix with level and delay adjustments at all cross points.

The DS100 is a versatile tool for use within complex audio systems to route and distribute multiple audio channels to numerous amplifiers driving loudspeaker positions and zones, show relay and break out rooms. The networking capabilities with a Dante enabled processor are significant, particularly for busy, multi-room complexes.

The DS100 completely integrates with the overall d&b system approach, including loudspeakers, amplifiers, rigging, transport and networking accessories and the DS10 Audio network bridge, which interfaces between Dante audio networking and the AES3 inputs of the d&b amplifiers. The DS100 and DS10 both operate on standard networking technologies, making them flexible and efficient. The complete system is designed and optimized in the d&b ArrayCalc simulation software, and controlled via the d&b R1 Remote control software.

The comprehensive input processing provides gain, EQ, delay and polarity switches, enabling the user to combine all types of input signals to create a mix from a wide variety of sources. Extended processing capabilities are also provided on every output.



The DS100 Signal Engine front view



The DS100 Signal Engine rear view

The d&b amplifiers

The d&b amplifiers are designed specifically to power d&b loudspeakers and are the beating heart of the d&b System Reality. As such, they incorporate Digital Signal Processing for comprehensive loudspeaker management, switchable filter functions, remote capabilities and user-definable controls, to fulfil the exact needs of each application.

Every loudspeaker configuration combines comprehensive system limiting, equalization and crossover settings to ensure consistent results and optimal performance. d&b amplifiers offer different output configurations for different loudspeaker setups, including Dual Channel mode, for passive setups, Mix TOP/SUB mode, in which two channels are driven through a single output connector, and 2-Way Active mode, which also sends the output of two channels down one connector to drive appropriate loudspeakers actively.

The d&b switch functions provide selected filters to precisely tailor a wide variety of setups to their applications. Examples of these switch functions are the CSA (Cardioid Subwoofer Array) and HFC (High Frequency Compensation) modes. CSA increases low frequency directivity control by minimising energy transmission towards the rear while HFC compensates for air absorption for loudspeakers covering far field listening positions. In addition to these functions, d&b amplifiers offer a comprehensive set of specific filters such as CUT, a cut mode for TOP loudspeakers when used with d&b subwoofers; CPL, to compensate for the coupling effect between loudspeakers in close proximity to other loudspeakers or hard objects and HFA mode, to attenuate the high frequencies of a loudspeaker to mimic the effect of far field listening. d&b amplifiers offer extended, user-definable equalization and delay capabilities, eliminating the need for external processing devices in the signal chain.

Sophisticated protection circuits modelling thermal and mechanical driver behaviour are provided, resulting in the sustained reliability of d&b systems. These amplifiers also have the functionality to enable system status monitoring and protection features, increasing the longevity of d&b systems. These features are designed for incorporation in applications specified to the requirements of sound systems for emergency purposes. A password protected LOCK function prevents unauthorized changes. The AutoStandby option automatically changes the D20 and D80 amplifiers to Standby mode after

a predefined time without any signal to individually specified inputs. The AutoWakeup function reactivates the amplifier when an input signal is active.

A powerCON¹ mains connector socket is fitted on the rear panel. The switched mode power supply of each amplifier incorporates mains overvoltage protection, inrush current limiting and loudspeaker protection at start up. Temperature and signal controlled fans cool the internal assemblies. d&b amplifiers offer analog and digital AES3 signal inputs, with link outputs for each channel. The AES3 link output carries a refreshed signal, while a power fail relay is incorporated to prevent interruption of the signal chain, in the event of a power failure. All d&b amplifiers integrate with the d&b Remote network to enable the remote control and management of systems from anywhere within a network. Firmware updates containing new loudspeaker configurations or additional functions can be loaded to the amplifiers via the d&b Remote network.

For permanently installed applications, the d&b 10D and 30D amplifiers are recommended. Further information is available in the d&b xD Installation Amplifier and Software brochure, which is available to download from www.dbaudio.com.



D6 amplifier



D20 amplifier



D80 amplifier

The d&b amplifiers

Input routing

The D20 amplifier and D80 amplifier provide four analog inputs, four digital AES3 channels and analog and digital link outputs, all on XLR connectors. The digital input pairs contain independent Sample Rate Converters (SRC). Each input features a separate input gain, meaning sources with various input sensitivities can be used without requiring an external mixing device. Individual inputs can be summed and routed to any of the four outputs.

System status monitoring

d&b amplifiers incorporate specific functions to check, monitor and control a d&b system. The System check feature can verify the status of a complete reinforcement system by measuring the impedance of the connected loudspeakers. Each driver in the system is checked and compared to the default impedance values for each particular cabinet. This calibration ensures that each loudspeaker performs within a tolerance band, and indicates possible damage to system components. The Input monitoring function can detect an incoming pilot signal regardless of whether this input is routed to an output. The Load monitoring function can detect a possible loudspeaker malfunction. This feature automatically checks load impedance to calculate individual driver status and report any failure. The Fallback and Override features within the D20 and D80 amplifiers ensure that any secondary or emergency signal is transmitted when required. The Fallback function ensures that the device will switch from the program material to an alternative source via a different input. The Override feature ensures that any general message or emergency signal takes priority. Fallback and Override can be triggered manually or automatically. These functions ensure the d&b amplifiers are suitable for applications specified to the requirements of evacuation systems for emergency purposes.

Integrated Web Remote interface

The D20 and D80 amplifiers can be controlled via the integrated web interface, which enables the Remote control of a single device using a browser window. Once the amplifier is connected to the d&b Remote network, an intuitive user interface becomes available after the IP address of the device is entered into the address bar of a web browser. Each amplifier in a system is managed individually, meaning that a new window or tab will be required for each device. The amplifiers can be accessed using a mobile device if the network features a wireless access point.

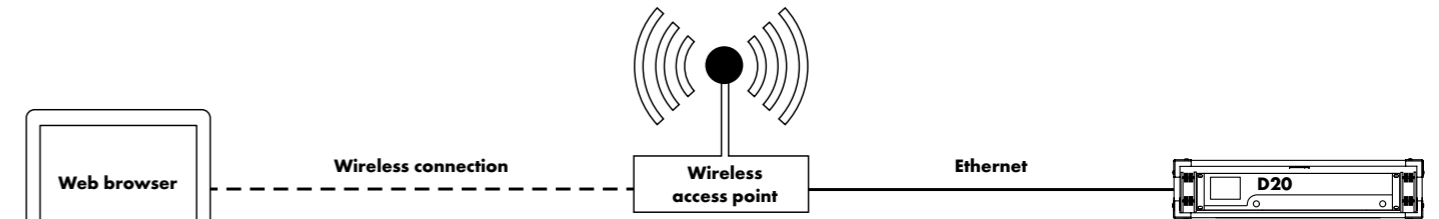

Application controlled via web browser for small setups



Input gain



Override



Fallback

The d&b amplifiers

Comparison of the d&b amplifiers

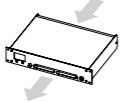
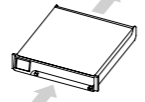
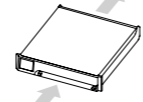
	D6	D20	D80
User interface	Encoder/LC display	Encoder/colour TFT touchscreen	Encoder/colour TFT touchscreen
Output channels	2	4	4
Input channels	2 x AES3 or 2 x analog	4 x AES3 or 4 x analog or 2 x AES3 and 2 x analog	4 x AES3 or 4 x analog or 2 x AES3 and 2 x analog
Latency	0.3 msec	0.3 msec	0.3 msec
User equalizers (per channel)	4-band	2 x 16-band	2 x 16-band
Delay	340 msec/116.9 m	10 sec/3440 m	10 sec/3440 m
Rated output power (THD+N < 0.5%, 12 dB crest factor)	2 x 350 W into 8 ohms 2 x 600 W into 4 ohms	4 x 800 W into 8 ohms 4 x 1600 W into 4 ohms	4 x 2000 W into 8 ohms 4 x 4000 W into 4 ohms
Output routing	Dual Channel w/o B1 and B2	Dual Channel, Mix TOP/SUB 2-Way Active	Dual Channel, Mix TOP/SUB 2-Way Active
Output connectors	NL4	NL4 plus central NL8	NL4/EP5 plus central NL8
Cable compensation	No	LoadMatch	LoadMatch
Power supply	Autosensing switched mode power supply with active PFC	Universal range switched mode power supply with active PFC	Autosensing switched mode power supply with active PFC
Mains voltage	100 - 120/220 - 240, 50 - 60 Hz	100 - 240 V, 50 - 60 Hz	100 - 127/208 - 240 V, 50 - 60 Hz
Weight (kg/lb)	8/17.6	10.8/23.8	19/42
Dimensions	2 RU x 19" x 353 mm	2 RU x 19" x 460 mm	2 RU x 19" x 530 mm
Remote	CAN	OCA via Ethernet/CAN	OCA via Ethernet/CAN
Airflow			

The D6 amplifier

The 2 RU two channel lightweight D6 amplifier delivers medium power into low impedance loads between 4 and 16 ohms and is ideally suited for use in both mobile and installation environments. The D6 contains setups for d&b loudspeakers and a linear mode; exceptions are 2-Way Active mode, V-Series and B22-SUB. The signal delay capability enables user definable settings of up to 340 msec (=100 m/328.1 ft) to be applied independently to each channel. The same applies to the 4-band parametric equalizer, providing optional boost/cut or notch filtering.

The D6 incorporates a digital rotary encoder and a LC display to configure the amplifier.

The D6 incorporates Class D amplifiers utilizing a switched mode power supply with active Power Factor Correction (PFC), suitable for mains voltages 100 V/120 V/200 V/240 V, 50 - 60 Hz and maintains a stable output when used with weak or unstable mains supplies. It is supplied with two NL4 loudspeaker output connectors.

Control and indicators

POWERMains power switch
 SCROLL/EDIT..... Digital rotary encoder
 Display Liquid Crystal Display (LCD)/120 x 32 pixel
 ISP, GR, OVL A/B..... LED indicators

Digital Signal Processing

Equalizer 4-band PEQ/Notch
 Latency analog and digital inputs.....0.3 msec
 Delay setting0.3 - 340 msec with 0.1 msec detents
 Configurations.....current d&b loudspeakers and linear mode
except 2-Way Active, V-Series and B22-SUB
 Function switchesd&b loudspeaker specific circuits
 Frequency generatorPink noise or Sine wave
 Sampling rate..... 96 kHz/27 Bit ADC/24 Bit DAC

Connectors

INPUT ANALOG (A1, A2)..... 3 pin XLR female
 ANALOG LINK (A1, A2) 3 pin XLR male
 INPUT DIGITAL (D1, D2)3 pin XLR female AES3
 DIGITAL LINK (Output) 3 pin XLR male
 Sampling rate.....48 kHz/96 kHz
 OUT CHANNEL A/BNL4
 REMOTE.....2 x RJ 45 parallel, CAN-Bus
 SERVICEUSB type B
 Mains connector.....powerCON¹

Data (linear setting with subsonic filter)

Maximum output power per channel (THD + N < 0.5 %, both channels driven).....
 CF = 6 dB at 4/8 ohms 2 x 600/350 W
 CF = 12 dB at 4/8 ohms 2 x 600/350 W
 S/N ratio (unweighted, RMS)..... > 110 dB

Power supply

Autosensing switched mode power supply with active Power Factor Correction (PFC).....
 Rated mains voltage
 High range 208 - 240 V, 50 - 60 Hz
 Low range 100 - 127 V, 50 - 60 Hz

Dimensions, weight

Height x width x depth..... 2 RU x 19" x 353 mm/13.9"
 Weight..... 8 kg (17.6 lb)



The D6 amplifier front view



The D6 amplifier rear view

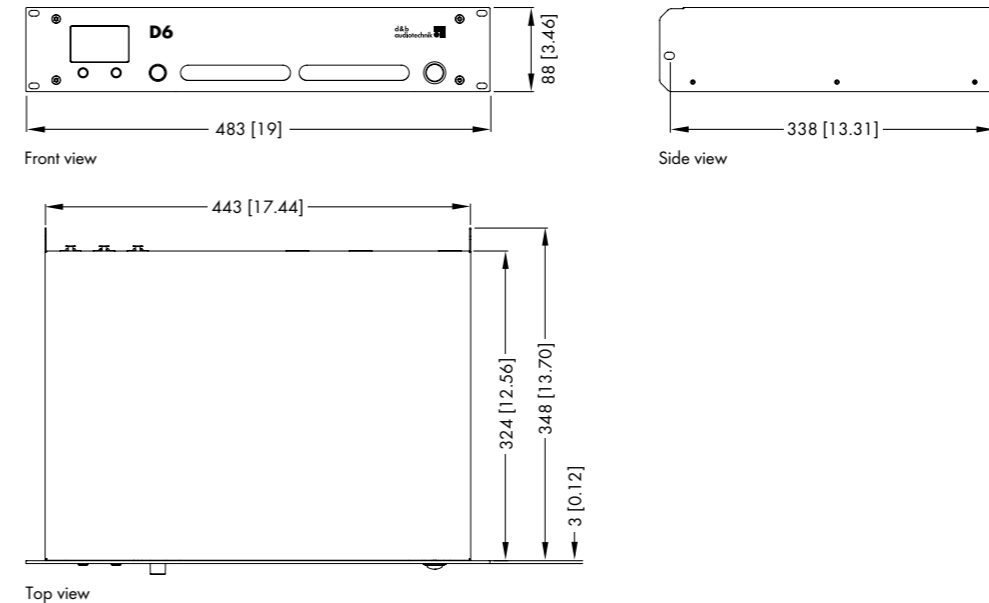

D6 amplifier dimensions in mm [inch]

The D20 amplifier

The 2 RU four channel D20 amplifier is ideally suited to mobile applications which require low to medium Sound Pressure Level (SPL) capabilities. The D20 features the same Digital Signal Processing (DSP) platform as the latest generation of d&b amplifiers, containing configurations for all d&b loudspeakers except the 2-Way Active loudspeakers, and a linear mode. The signal delay capability enables user definable settings of up to 10 s (= 3440 m/11286 ft), which can be applied independently to each channel. The same applies to the two 16-band equalizers, providing optional parametric, asymmetric, shelving or notch filtering.

The D20 incorporates a colour TFT touchscreen, offering quick access to the menu structure, while the rotary encoder can be used for fine adjustment. The front panel and the integrated touchscreen are tilted up for easy operation when the amplifier is below eye level.

The equal ratio of signal input to amplifier output channels increases application flexibility particularly for monitor, frontfill or effect channel use. The LoadMatch function integrated within the D20 amplifier electrically compensates for the properties of loudspeaker cable used.

The D20 incorporates Class D amplifiers utilizing a power supply with active Power Factor Correction (PFC) suitable for mains voltages 100 V - 240 V, 50 - 60 Hz and maintains a stable output when used with weak or unstable mains supplies. An NL8 provides all outputs on a single connector for loudspeaker multicores. Dual channel mode is driven through four individual NL4 connectors, while Mix TOP/SUB and 2-Way Active mode output configurations for applicable d&b loudspeakers are available via two dedicated NL4 connectors.

Control and indicators

POWERMains power switch
 SCROLL/EDIT..... Digital rotary encoder
 Display Colour TFT touchscreen, 3.5"/320 x 240 pixel

Digital Signal Processing

Equalizer2 x 16-band PEQ/notch/shelving/asymmetric
 Latency analog and digital inputs.....0.3 msec
 Delay setting 0.3 - 10000 msec
 Configurations.....current d&b loudspeakers and linear mode
except 2-Way Active loudspeakers
 Function switchesd&b loudspeaker specific circuits
 Frequency generatorPink noise or Sine wave
 Sampling rate.....96 kHz/27 Bit ADC/24 Bit DAC

Connectors

INPUT ANALOG (A1 - A4) 3 pin XLR female
 ANALOG LINK (A1 - A4) 3 pin XLR male
 INPUT DIGITAL (D1/2, D3/4)3 pin XLR female AES3
 DIGITAL LINK (Output) 3 pin XLR male
 Sampling Digital AES348 kHz/96 kHz
 SPEAKER OUTPUTS A/B/C/DNL4
 Mix TOP/SUB/2-Way Active output A/B and C/D.....NL4
 4 CHANNEL OUTPUTNL8
 CAN 2 x RJ 45 parallel
 ETHERNET2 x etherCON¹, 10/100 Mbit Ethernet
 Mains connectorpowerCON¹

Data (linear setting with subsonic filter)

Maximum output power per channel (THD + N < 0.5 %, all channels driven).....
 CF = 6 dB at 4/8 ohms 4 x 1000/800 W
 CF = 12 dB at 4/8 ohms 4 x 1600/800 W
 S/N ratio (unweighted, RMS).....
 Analog input > 104 dB
 Digital input > 106 dB

Power supply

Universal range switched mode power supply with active Power Factor Correction (PFC).....
 Rated mains voltage 100 - 240 V, 50 - 60 Hz

Dimensions, weight

Height x width x depth2 RU x 19" x 460 mm/18.1"
 Weight..... 10.8 kg (23.8 lb)



The D20 amplifier front view



The D20 amplifier rear view

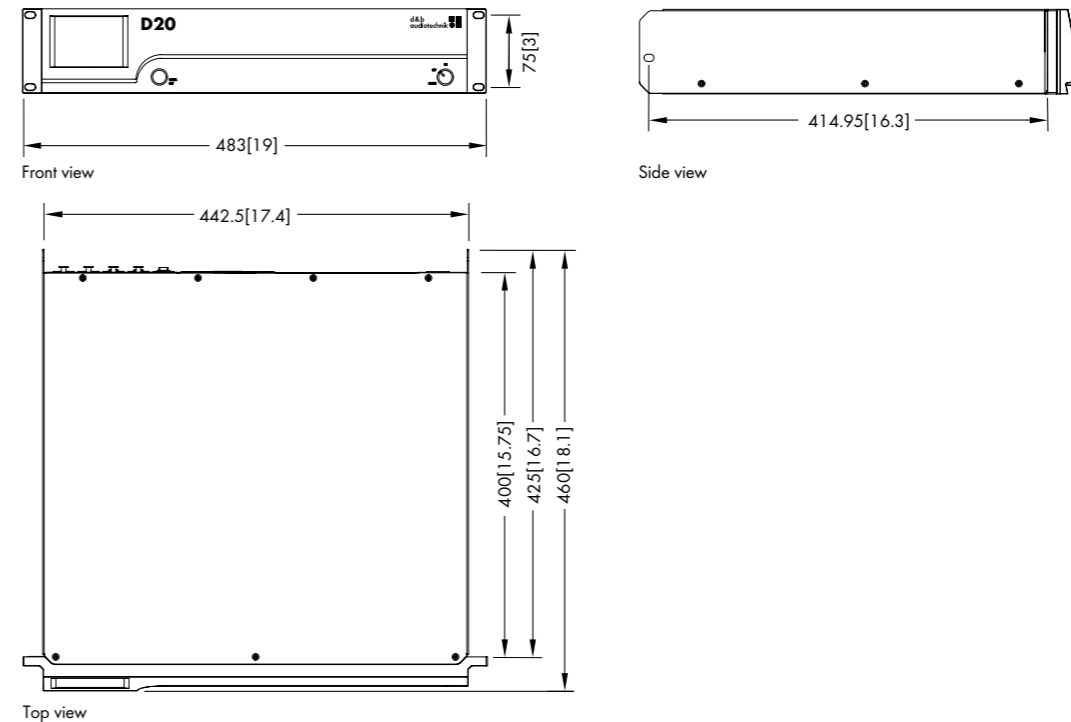

D20 amplifier dimensions in mm [inch]

The D80 amplifier

The 2 RU four channel D80 amplifier is a high power density amplifier, ideally suited for use in both mobile and installation environments.

It contains setups for all d&b loudspeakers and a linear mode. The signal delay capability enables user definable settings of up to 10 s (= 3440 m/11286 ft) to be applied independently to each channel. The same applies to the two 16-band equalizers, providing optional parametric, asymmetric, shelving or notch filtering. The R1 Remote control section of this brochure gives a full explanation of the equalization section of the D80 amplifier.

The D80 incorporates a colour TFT touchscreen, offering quick access to the menu structure, while the rotary encoder can be used for fine adjustment. The front panel and the integrated touchscreen of the D80 amplifier is tilted up for ease of operation when the amplifier is below eye level.

The equal ratio of signal input to amplifier output channels increases the application flexibility particularly for monitor, frontfill or effect channel use.

The LoadMatch function integrated within the D80 amplifier electrically compensates for the properties of loudspeaker cable used. The D80 incorporates Class D amplifiers utilizing a switched mode power supply with active Power Factor Correction (PFC) suitable for mains voltages 100 V/127 V, 50 - 60 Hz and 208 V/240 V, 50 - 60 Hz and maintains a stable output when used with weak or unstable mains supplies. An NL8 provides all outputs on a single connector, while individual outputs are optionally NL4 for EP5 connectors.

Control and indicators

POWERMains power switch
 SCROLL/EDIT..... Digital rotary encoder
 Display Colour TFT touchscreen, 3.5"/320 x 240 pixel

Digital Signal Processing

Equalizer2 x 16-band PEQ/notch/shelving/asymmetric
 Latency analog and digital inputs.....0.3 msec
 Delay setting 0.3 - 10000 msec
 Configurations.....current d&b loudspeakers and linear mode
 Function switchesd&b loudspeaker specific circuits
 Frequency generatorPink noise or Sine wave
 Sampling rate.....96 kHz/27 Bit ADC/24 Bit DAC

Connectors

INPUT ANALOG (A1 - A4)3 pin XLR female
 ANALOG LINK (A1 - A4)..... 3 pin XLR male
 INPUT DIGITAL (D1/2, D3/4)3 pin XLR female AES3
 DIGITAL LINK (Output)3 pin XLR male
 Sampling Digital AES3.....48 kHz/96 kHz
 SPEAKER OUTPUTS A/B/C/D NL4, optional EP5
 4 CHANNEL OUTPUTNL8
 CAN 2 x RJ 45 parallel
 ETHERNET.....2 x etherCON¹, 10/100 Mbit Ethernet
 Mains connector..... powerCON-HC¹

Data (linear setting with subsonic filter)

Maximum output power per channel (THD + N < 0.5 %, all channels driven).....
 CF = 6 dB at 4/8 ohms4 x 2600/2000 W
 CF = 12 dB at 4/8 ohms.....4 x 4000/2000 W
 S/N ratio (unweighted, RMS).....
 Analog input > 110 dB
 Digital input..... > 114 dB

Power supply

Autosensing switched mode power supply with active Power Factor Correction (PFC).....
 Rated mains voltage
 High range..... 208 - 240 V, 50 - 60 Hz
 Low range 100 - 127 V, 50 - 60 Hz

Dimensions, weight

Height x width x depth.....2 RU x 19" x 530.5 mm/20.9"
 Weight..... 19 kg (42 lb)



The D80 amplifier front view



The D80 amplifier rear view

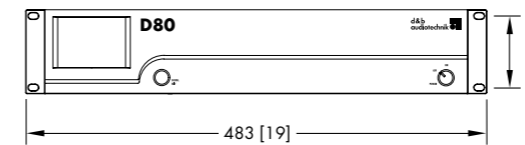

Front view

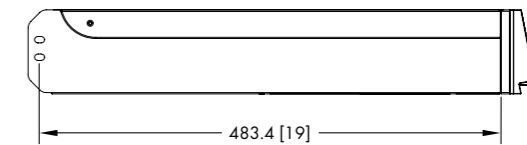

Side view

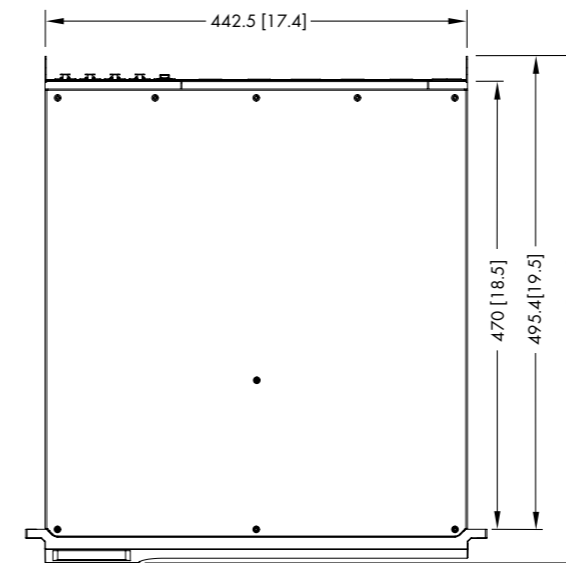

Top view

D80 amplifier dimensions in mm [inch]

The 3 x D20 and 3 x D80 Touring rack assemblies

The D20 and D80 Touring rack assemblies are designed as fully equipped and prewired system racks, providing mains power distribution, connector interfaces and all internal cabling for three D20 or D80 amplifiers. They are both equipped with a 32 A CEE mains power connector, a mains distribution device with a 32 A mains link, and a loudspeaker connector panel.

All internal audio and remote connections are fully prewired. A loom comprising two AES3 cables and one CAT5/etherCON¹ is supplied, providing patch cabling for a network connection and four AES3 channels. The D20 and D80 Touring rack assemblies are provided with either a DS10 or DS20 Audio network bridge, which comes supplied with all necessary cabling, or a 1 RU drawer.

The 10 RU Touring racks house a 19" internal shockmount steel frame accommodating three D20 or D80 amplifiers and the requisite connection panels as detailed on the next page. They feature two sliding doors, a perspex window at the front, four wheels, six handles and recessed stacking moulds at the top.



3 x D20 Touring rack front view



3 x D80 Touring rack front view

The DS10 Audio network bridge and DS20 Audio network bridge provide 16 AES3 outputs via Dante or Milan transport protocols respectively, and are intended to integrate directly into a D80 Touring rack assembly. The front panels of the audio network bridges are designed to align with the input panel of the D80 Touring rack assembly. The DS10 and DS20 can be powered by one of the auxiliary mains outputs. All necessary patch cabling and links are supplied with a D80 Touring rack assembly including a DS10 or DS20.

The I/O panel provides the input connectors of the first amplifier while the other two amplifiers are linked within the rack. The INPUT section allows both analog and digital audio signals to be fed while the INPUT LINK section provides the link output connectors of the last amplifier.

The REMOTE section allows the daisy chaining of system racks within a remote network using the enclosed rack link cable. ETH 1 provides the upper etherCON¹ connector of the first amplifier, ETH 2 provides the bottom etherCON¹ connector of the last amplifier.

CAN input provides the CAN input of the first amplifier while the other two amplifiers are linked within the rack. The last CAN-Bus device of a CAN-Bus segment can be terminated by the TERMINATE switch.

The Mains power distributor panels are designed and dimensioned to provide and distribute the mains power supply necessary for the three D20/D80 amplifiers.

They also serve as a loudspeaker connection panel. The D20 Touring rack features three NL8 sockets to allow connection to a total of twelve amplifier channels. The D80 Touring rack includes three NL8 and one additional LKA25 multicore connectors.

Three electrically interlocked auxiliary mains outputs (powerCON¹ 16 A sockets) are provided. They are intended for the connection of low current devices such as notebooks or additional Ethernet switches. Three phase mains indicators are provided.

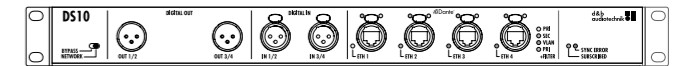

Z4010
DS10 Audio network bridge

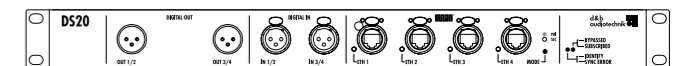

Z4011
DS20 Audio network bridge

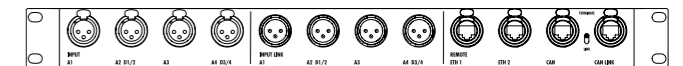

Z5338
I/O Panel 19", 1 RU

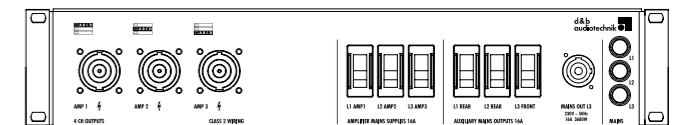

X5565
Mains/LS Panel D20 CEE NL8

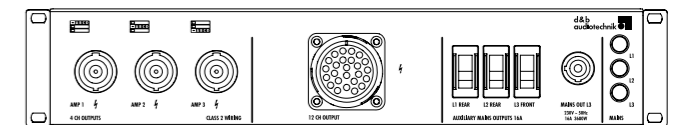

Z5566
Mains/LS Panel NL8/LKA25

The 3 x D20 and 3 x D80 Touring rack assemblies

3 x D20 Touring rack

Z5560.xxx

Total weight including amplifiers:
98.5 kg (217 lb)

Z5561.xxx

Total weight including amplifiers:
97.5kg (215 lb)

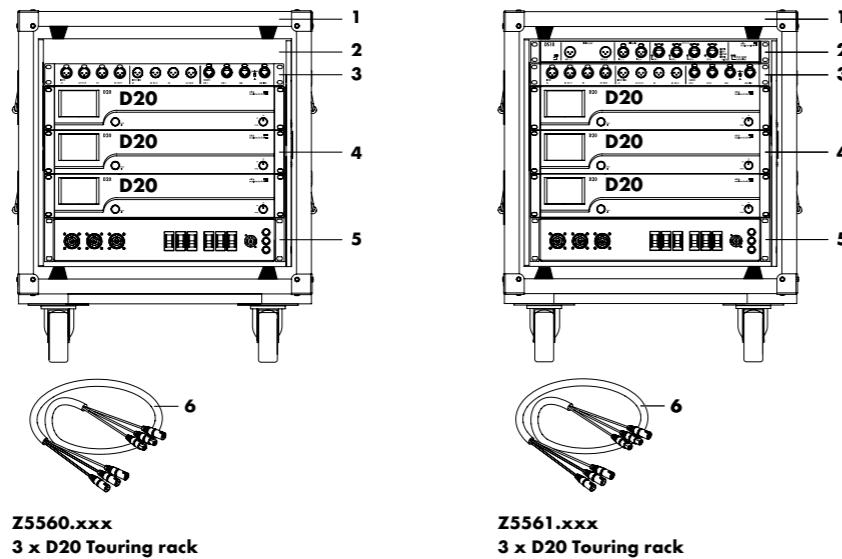

Z5560.xxx
3 x D20 Touring rack

Z5561.xxx
3 x D20 Touring rack

3 x D80 Touring rack

Z5570.xxx

Total weight including amplifiers:
128 kg (282 lb)

Z5571.xxx

Total weight including amplifiers:
127 kg (280 lb)

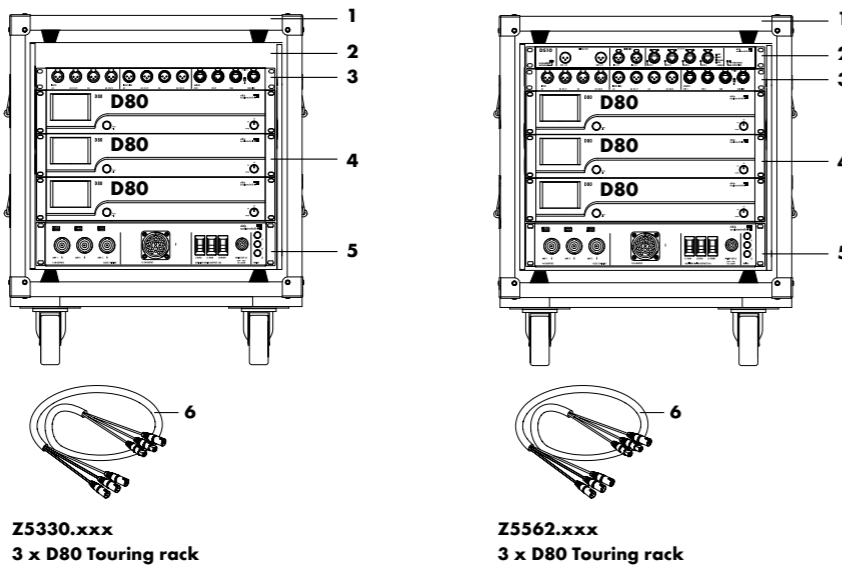

Z5330.xxx
3 x D80 Touring rack

Z5562.xxx
3 x D80 Touring rack

Key

- 1 - Touring rack 10 RU
- 2 - Rack drawer or DS10/DS20
- 3 - I/O panel
- 4 - D20/D80 amplifiers
- 5 - Mains power distributor
- 6 - Rack link

A maximum of two D20 and D80 Touring rack assemblies can be linked to the 32 A CEE 5P mains supply.

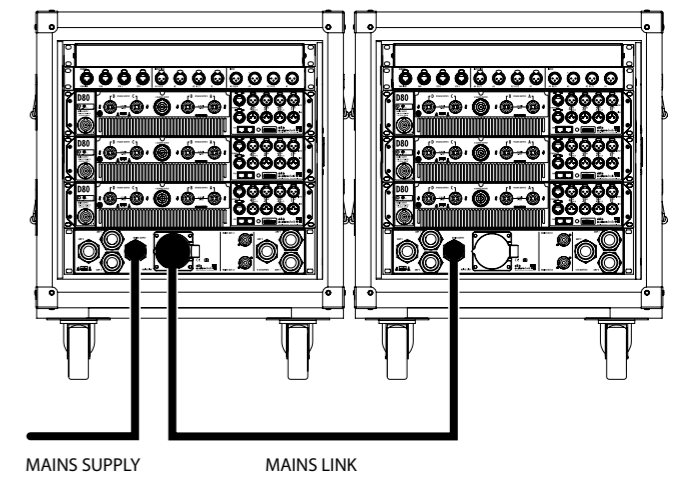

Sliding doors at front and back allow for quick and effective deployment on site.

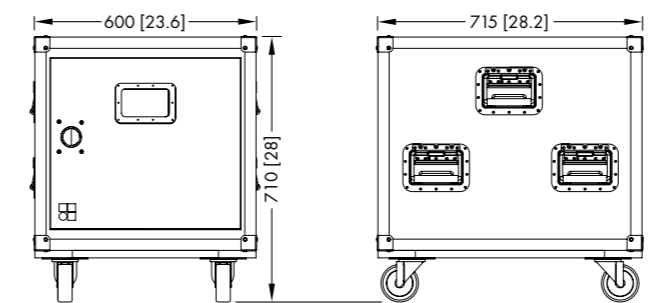
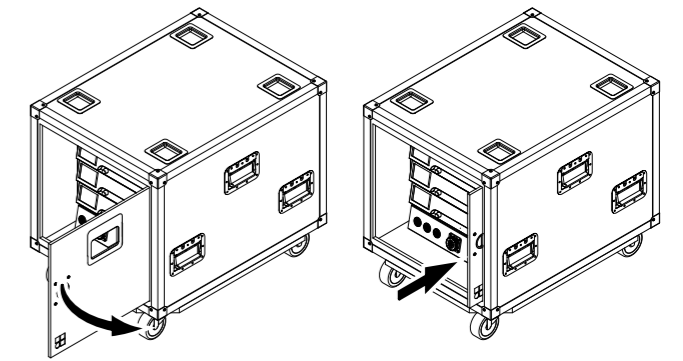

3 x D20 Touring rack dimensions in mm [inch]

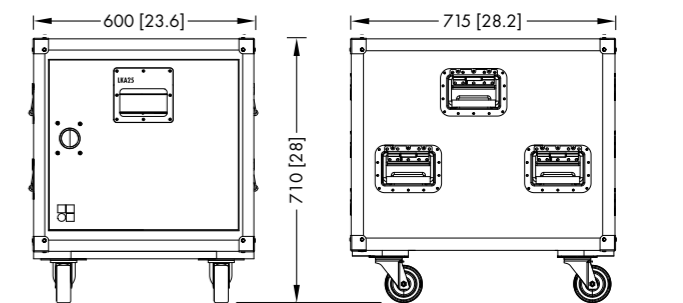

3 x D80 Touring rack dimensions in mm [inch]

The 6 x D80 Touring rack assembly

The d&b 6 x D80 Touring rack assembly and the d&b 3x D80 Touring rack assembly are intended for large scale sound reinforcement applications. They are designed as a complete prewired system amplification rack providing mains power distribution, connector interfaces and all internal cabling for D80 amplifiers.

The 19" internal shockmount steel frame also accommodates a d&b DS10 or DS20 Audio network bridge and an I/O panel providing both analog and digital audio signals as well as four network connectors for either Ethernet or CAN-Bus remote Networking.

The d&b Audio network bridges interface between audio transport networks and AES3 digital audio signals while also providing distribution of Ethernet control data. The DS10 supports Dante networks, while the DS20 is used for the open standards-based Milan protocol.

The Audio network bridges each incorporate an integrated 5-port switch, offering a primary and redundant network. The DS20 5-port switch is fully AVB enabled, while the DS10 offers special functions such as Multicast Filtering and VLAN modes. The d&b 6 x D80 Touring rack assembly comes with a 2 RU loudspeaker connector panel providing six NL8 (4 channel) and two LKA25 (12 channel) loudspeaker outputs. The loudspeaker connector panel is also equipped with a Power over Ethernet (POE) socket to connect and power a d&b ArraySight inclinometer. The d&b ArraySight inclinometer system is intended to vertically aim an entire array in its operation position. It provides precision angle measurement over a wide measuring range of ± 90 degrees. It utilizes an ultra bright green laser to provide a visible indication for aiming the array. The d&b ArraySight sender unit also sends temperature and humidity information to the R1 Remote control software via OCA/AES70. The d&b 3 x D80 Touring rack assembly provides three NL8 (4 channel) and one LKA25 (12 channel) loudspeaker output. Both touring Racks are available with a 32 A CEE mains power distribution or 30 A NEMA mains power distribution panel.



The necessary patch cabling for the DS10 and DS20 Audio network bridges and I/O panel are prewired. The digital outputs of the DS10 (OUT 1/2 and OUT 3/4) are linked to the corresponding input sockets (A2 D1/2 and A4 D3/4) of the I/O panel to feed the digital audio signals to the amplifiers. In addition, the ETH 3 connector of the DS10 is linked to the ETH 1 connector of the I/O panel to provide access to the amplifiers.

The Z5578 Loudspeaker connector panel acts as a connecting interface providing all output channels of each amplifier on its dedicated NL8 socket (4 channels) and two LKA25 connector sockets (12 channels each), which directly integrate into the d&b MC24 multicore system.

The Z5577 Mains power distributor 32 A CEE is designed and dimensioned to provide and distribute the mains power supply necessary for one Z5576.000 Touring rack assembly.

The Z5577.001 Mains power distributor is supplied with two NEMA 30 A 3ØY 120/208 VAC sockets. Each connector socket provides mains power for three D80 amplifiers.

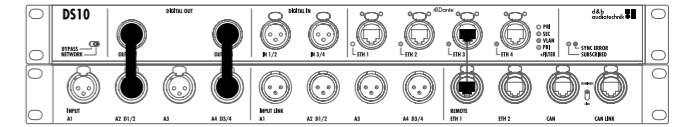

Z4010 DS10 Audio network bridge with Z5338 I/O Panel 19", 1 RU

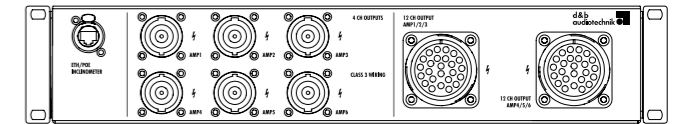

Front view

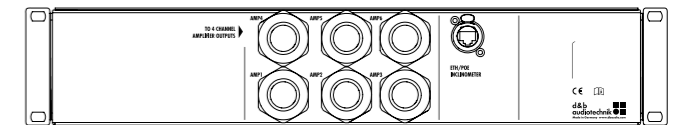

Rear view

Z5578 Loudspeaker connector panel 2 x LKA25/6 x NL8

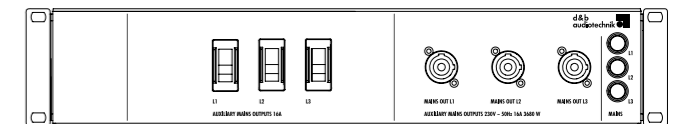

Front view

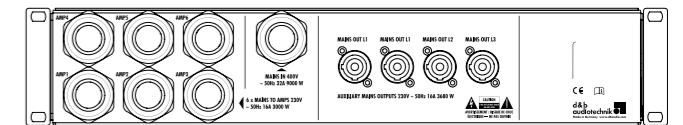

Rear view

Z5577.000 Mains power distributor 32 A CEE

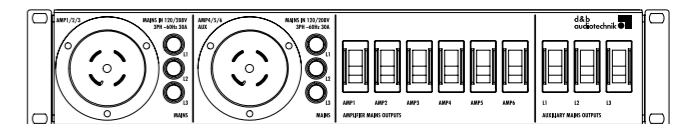

Front view

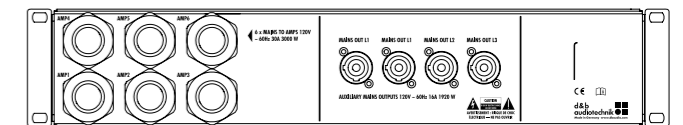

Rear view

Z5577.001 Mains power distributor 2 x 30 A NEMA

The 6 x D80 Touring rack assembly

Z5576.000

Total weight including amplifiers:
210 kg (463 lb)

Key

- 1 - Touring rack 18 RU
with shock mounted 19" frame
- 2 - Mains power distributor
- 3 - LS Connector panel 2 x LKA 25/6 x NL8
- 4 - D80 amplifiers
- 5 - I/O Panel
- 6 - DS10/DS20 Audio network bridge
- 7 - POE (Power Over Ethernet) injector device
- 8 - Rack link

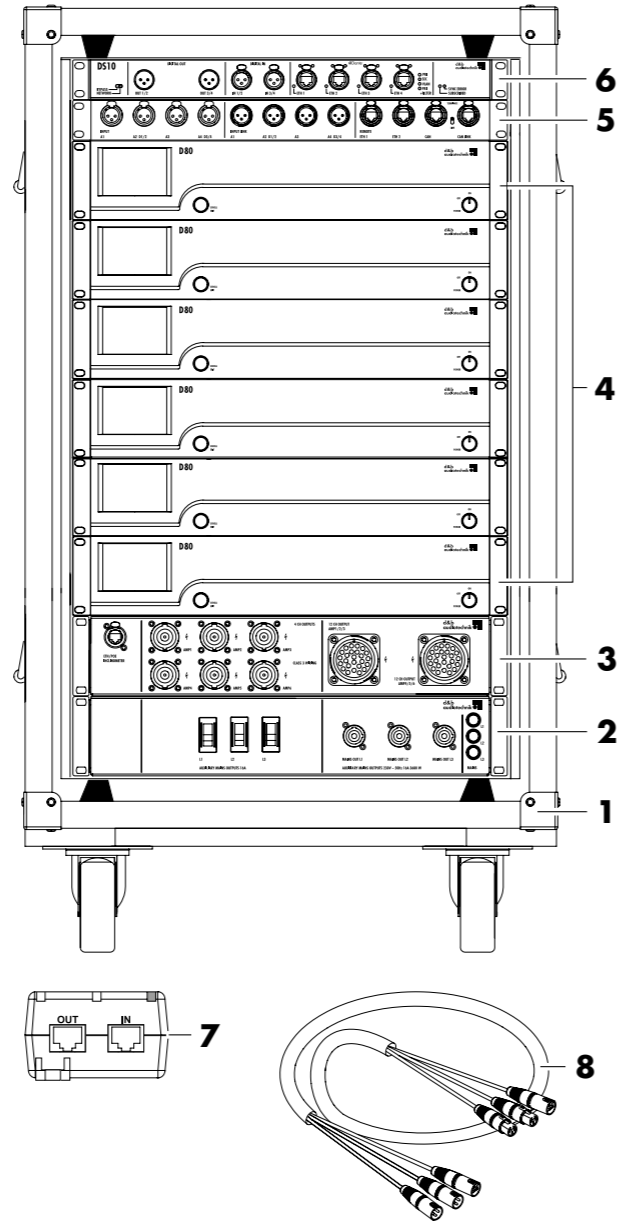

Sliding doors at front and back allow
for quick and effective deployment on site.

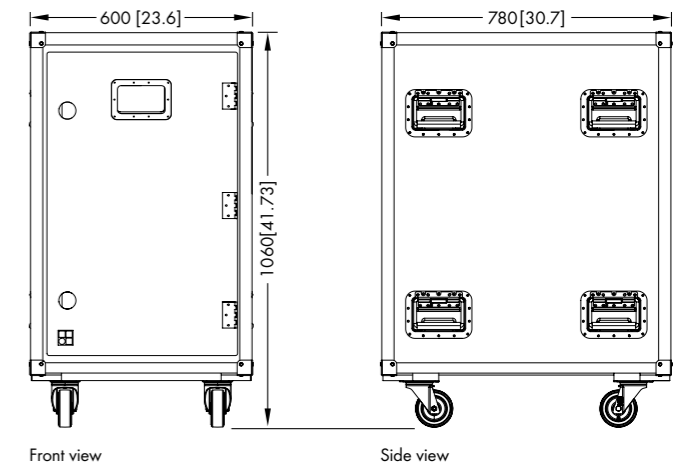
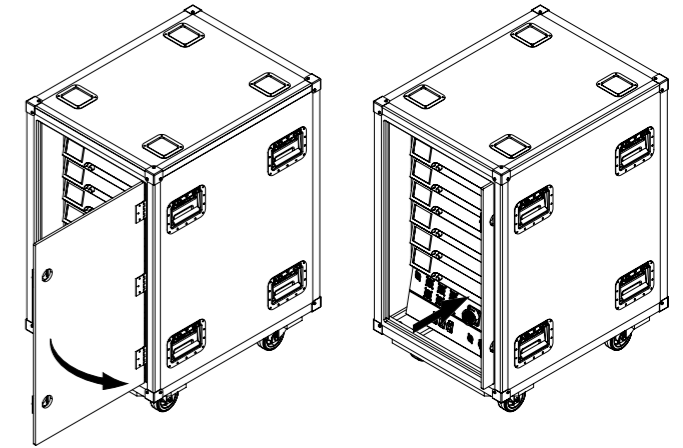

Front view Side view
Z5576 D80 Touring rack assembly dimensions in mm [inch]

The cables and adapters for Dual Channel mode

Amplifiers in Dual Channel mode

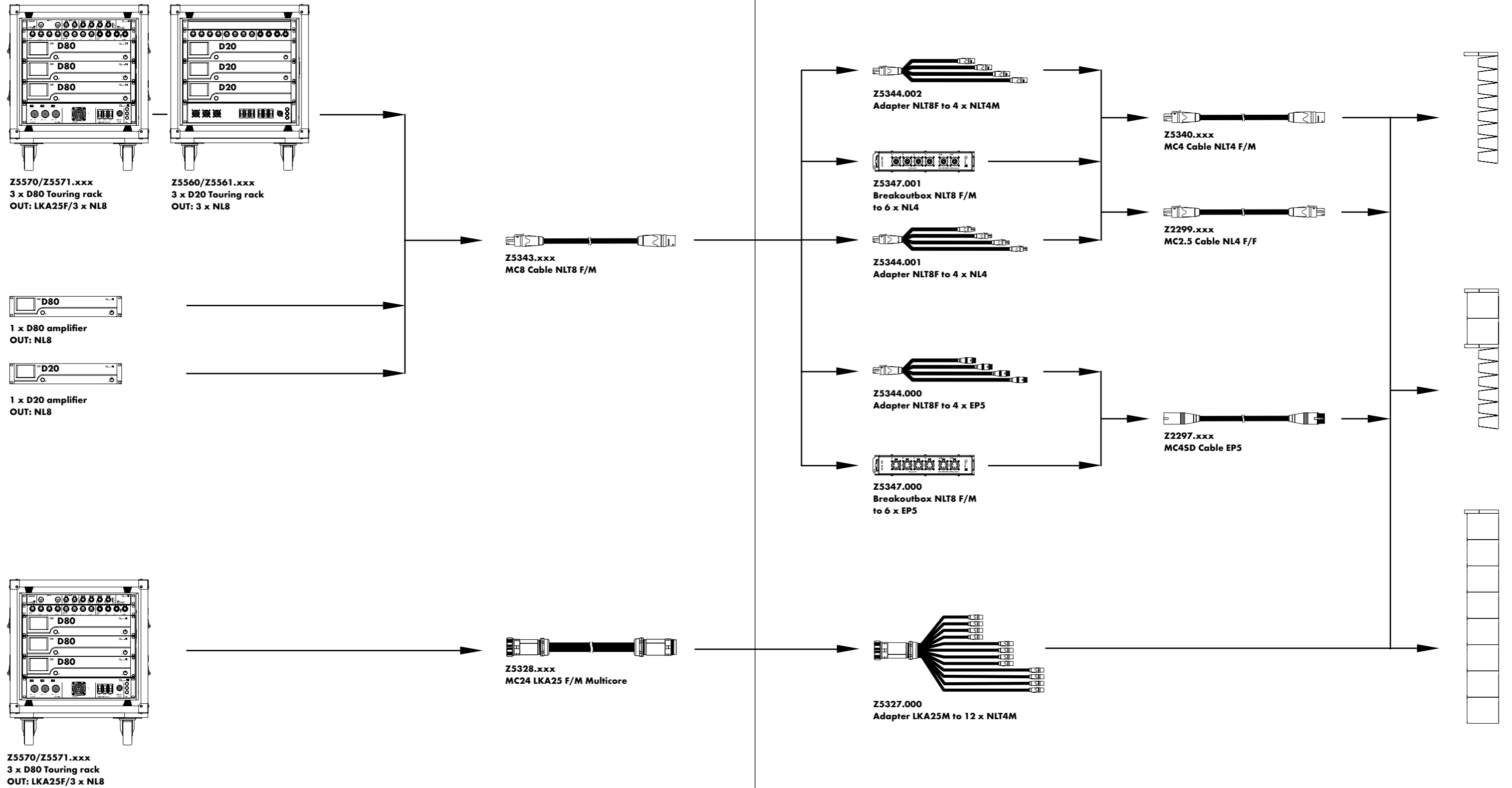

The cables and adapters for Dual Channel mode

Amplifiers in Dual Channel mode

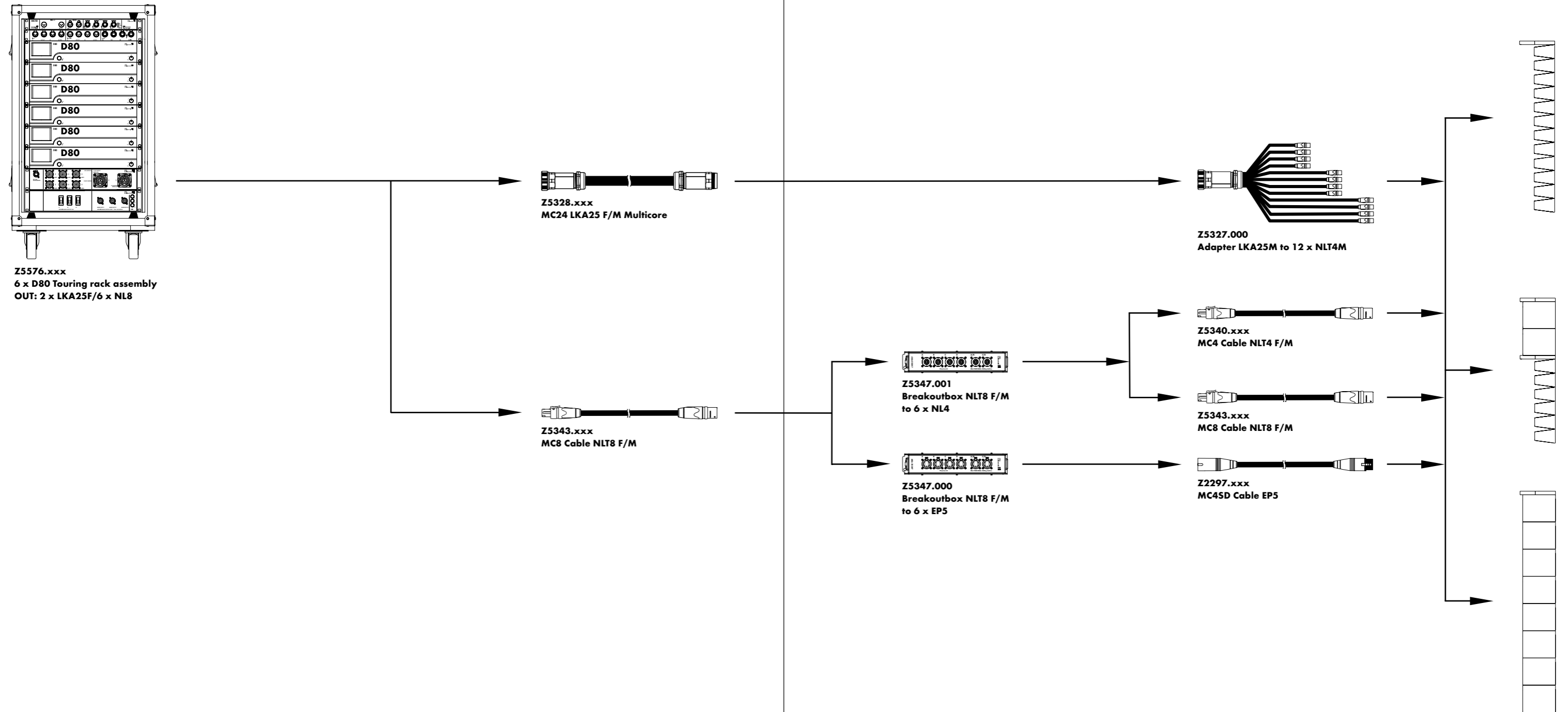

The cables and adapters for 2-Way Active and Mix TOP/SUB modes

Amplifiers in 2-Way Active and Mix TOP/SUB modes

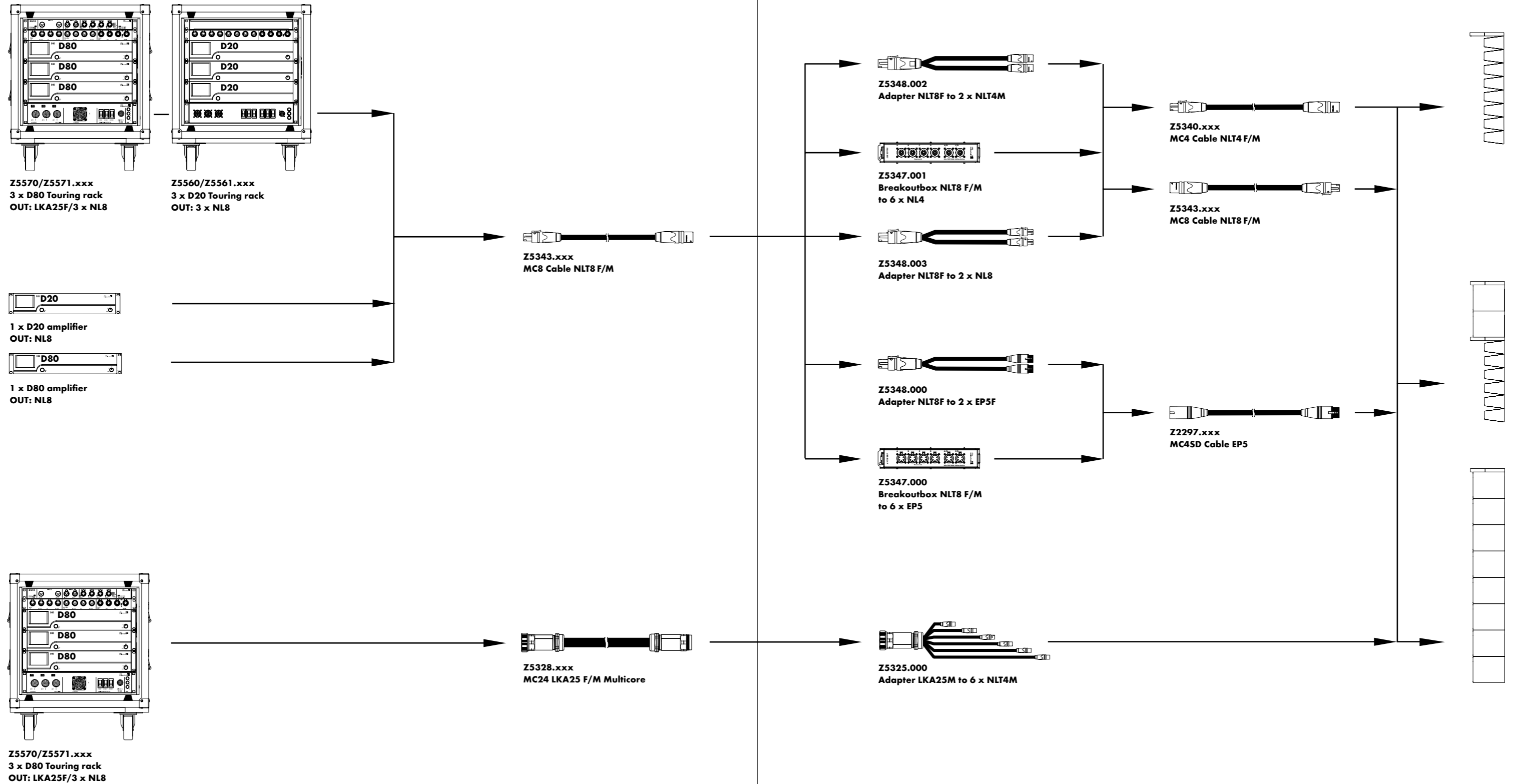

The cables and adapters for 2-Way Active and Mix TOP/SUB modes

Amplifiers in Dual 2-Way Active mode and Mix TOP/SUB modes

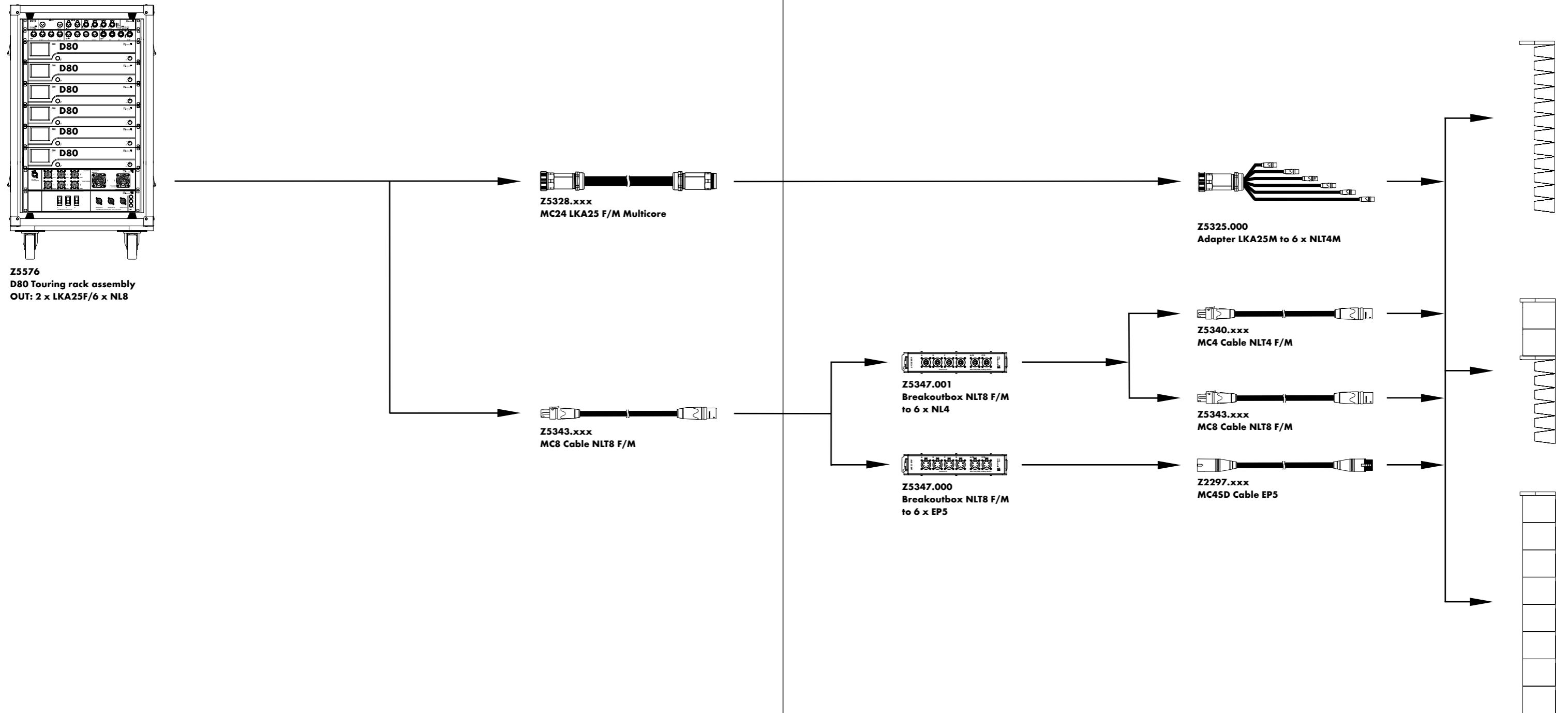

The amplifiers and software product overview

Processing and distribution	Z4010.000	DS10 Audio network bridge
	Z4011.000	DS20 Audio network bridge
	Z4100.000	DS100 Signal Engine
Amplifiers	Z2700.000	D6 amplifier NL4
	Z2700.400	D6 amplifier China NL4
	Z2700.500	D6 amplifier USA NL4
	Z2750.000	D20 amplifier NL4
	Z2750.400	D20 amplifier China NL4
	Z2750.500	D20 amplifier USA NL4
	Z2710.000	D80 amplifier EP5
	Z2710.001	D80 amplifier NL4
	Z2710.400	D80 amplifier China EP5
	Z2710.401	D80 amplifier China NL4
	Z2710.501	D80 amplifier USA NL4
Amplifier rack assemblies	Z5560.xxx	3 x D20 Touring rack
	Z5561.xxx	3 x D20 Touring rack (includes DS10)
	Z5570.xxx	3 x D80 Touring rack
	Z5571.xxx	3 x D80 Touring rack (includes DS10)
	Z5576.xxx	6 x D80 Touring rack (includes DS10)
	Z5332.xxx	I/O Panel 19", 1 RU
	Z5577.000	Mains panel 2RU, 32A CEE
	Z5577.001	Mains Panel 2HE, 2x30A NEMA
	Z5578.000	LS panel 2xLKA25/6xNL8
	Z5566.000	Mains/LS Panel NL8/LKA25 CEE
Z5566.001	Mains/LS Panel NL8/LKA25 NEMA	
Racks	E7480.000	D20 Touring rack 2 RU, 19" SD , shock mounted, handles, window
	E7468.000	D80 Touring rack 2 RU, 19" SD , shock mounted, handles, window
	E7483.000	DS100 Touring rack 3 RU, 19" SD , shock mounted, handles
Remote network	Z6118.000	R60 USB to CAN interface
	Z6124.000	R70 Ethernet to CAN interface

